



# Series 2000 Entrance Door Price List

01.04.2021

**HÖRMANN**

---

## Hörmann (UK) Limited

Gee Road

Coalville

Leicestershire

LE67 4JW

Phone: 01530 513000

Fax: 01530 513001

info@hormann.co.uk



# Thermo46 / Thermo65 entrance doors



## Contents

Thermo46 entrance doors		From page
<b>TPS</b>		
	TPS product description and technical presentation	2
	TPS entrance doors	8
	Accessories for TPS entrance doors	11
	Side elements and transom lights	22
	Overview of panels / glass for side elements	23

Thermo65 entrance doors		From page
<b>THP</b>		
	THP product description and technical presentation	24
// NEW	THP with acoustic insulation product description and technical presentation	28
	THP entrance doors	36
	THP entrance door accessories	41
	Side elements and transom lights	56
	Overview of glass for side elements	57

**For further information on Thermo46 and Thermo65 entrance doors,  
see our brochure.**



# Thermo46 entrance doors

## Entrance door programme

## Product description

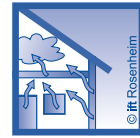

- Standard
- Optional

Product description		Thermo46 – steel TPS												
		010	015	515	020S	025S	030S	040S	100	2001	4001	700B	750C	900D
<b>Door leaf structure</b>														
Smooth sheet	"Modern"	●			●		●	●				●	●	●
Ribbed sheet	"Modern" (exterior)		●	●		●								
Panelled sheet	"Classic" (on both sides)								●	●	●			
Door leaf thickness		46 mm thick												
Sheet thickness		0.6–0.8 mm												
Fully foamed		●	●	●	●	●	●	●	●	●	●	●	●	●
With thermal break		●	●	●	●	●	●	●	●	●	●	●	●	●
Exterior and interior overlapping the leaf		●	●	●	●	●	●	●	●	●	●	●	●	●
<b>Size ranges (see also page 4)</b>														
Standard sizes (RAM)		1000 × 2100 mm and 1100 × 2100 mm												
Special sizes (RAM)		"Modern" type A						"Classic"			"Modern" type B			
	700–1250 mm Width 1875–2250 mm Height	●			●		●	●				●	●	
	800–1250 mm Width 1875–2250 mm Height													●
	875–1250 mm Width 1875–2250 mm Height		●	●		●								
	875–1100 mm Width 1875–2186 mm Height								●		●			
	875–1100 mm Width 1990–2186 mm Height									●				
<b>Surface finish</b>														
<b>Note:</b>		For doors with dark surfaces, the material expansion is particularly high. Therefore, please check the location of the door in the building during consultation. This will ensure trouble-free door operation.												
<b>Standard</b>														
	● Traffic white, based on RAL 9016	●	●	●	●	●	●	●	●	●	●	●	●	●
	● Painted on both sides	●	●	●	●	●	●	●	●	●	●	●	●	●
	● Silk matt, gloss level 35–40 %	●	●	●	●	●	●	●	●	●	●	●	●	●
<b>Preferred colour</b>														
	● 22 preferred colours													
	● Painted on both sides, based on the RAL colour chart													
	● Silk matt, gloss level 35–40 %													
	RAL 1015 Light ivory						RAL 7015 Slate grey			RAL 9001 Cream				
	RAL 3000 Flame red						RAL 7016 Anthracite grey			RAL 9002 Grey white				
	RAL 3003 Ruby red						RAL 7037 Dusty grey			RAL 9006 White aluminium				
	RAL 3004 Purple red						RAL 7035 Light grey			RAL 9007 Grey aluminium				
	RAL 5010 Gentian blue						RAL 7039 Quartz grey							
	RAL 5014 Pigeon blue						RAL 7040 Window grey							
	RAL 6005 Moss green						RAL 8003 Clay brown			CH 703 Anthracite metallic				
	RAL 7012 Basalt grey						RAL 8028 Terra brown			CH 907 Grey aluminium				
<b>Matt deluxe</b>														
	● 6 colours													
	● Painted on both sides													
	● matt, gloss level 3–8 %													
	CH 9016 Matt deluxe, Traffic white							CH 9006 Matt deluxe, White aluminium						
	CH 8028 Matt deluxe, Terra brown							CH 9007 Matt deluxe, Grey aluminium						
	CH 7016 Matt deluxe, Anthracite grey							CH 703 Matt deluxe, Anthracite metallic						
<b>Decor</b>														
	Golden Oak	●	●	●	●	●	●	●				●	●	●
	Dark Oak	●	●	●	●	●	●	●				●	●	●
	Night Oak	●	●	●	●	●	●	●				●	●	●
	Winchester Oak	●	●	●	●	●	●	●				●	●	●
	Titan Metallic CH 703	●	●	●	●	●	●	●				●	●	●
<b>Seals</b>														
	4-sided, double EPDM seals, black, with continuous lip seal in the bottom sheet, additional EPDM form parts in both bottom corners for additional sealing, incl. brush seal in the frame	●	●	●	●	●	●	●	●	●	●	●	●	●
<b>Lock</b>														
	Multiple-point locking with main lock (with soft lock latch) and 2 bolts, swing / hook bolt combination	●	●	●	●	●	●	●	●	●	●	●	●	●
<b>Electric strikes</b>														
	Electric strike with day catch (separate)	○	○	○	○	○	○	○	○	○	○	○	○	○



# Thermo46 entrance doors

## Entrance door programme

## Product description

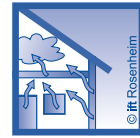

- Standard
- Optional

Product description	Thermo46 – steel TPS													
	010	015	515	020S	025S	030S	040S	100	2001	4001	700B	750C	900D	
<b>Security bolts</b>														
3 × anti-leverage guard	●	●	●	●	●	●	●	●	●	●	●	●	●	
<b>Thermal insulation value (in W/(m<sup>2</sup>·K))</b>														
► Dependent on the size and frame type	For a product description, see page 8 to 10													
<b>Properties (stated values in combination with standard threshold)</b>														
<b>EN 12207 – air permeability</b>	Class 2													
<b>EN 12208 – Water tightness under heavy rain</b>	Class 1A													
<b>EN 12219 – differential climate behaviour</b>	3c/2d/2e													
<b>Version in RC 2</b>														
<b>Attack side = closing side</b> (opposite hinge side)														
RC 2 with aluminium frame, hook bolt lock, profile cylinder with drilling and pull-off protection as well as security card	○	○	○					○						
RC 2 with aluminium frame, hook bolt lock, profile cylinder with drilling and pull-off protection as well as security card and safety glass (P4A)											○	○	○	
<b>Size ranges</b>														
Size ranges in which an RC 2 version is possible	832 – 1250 mm Width 1875 – 2250 mm Height	○										○	○	○
	875 – 1250 mm Width 1875 – 2250 mm Height		○	○										
	875 – 1100 mm Width 1875 – 2186 mm Height								○					
<b>Fittings</b>														
<b>Hinges</b>														
3 two-part guide rollers (180 mm), 3-way adjustable with cover caps (stainless steel look)	●	●	●	●	●	●	●	●	●	●	●	●	●	
<b>Door handle (exterior)</b>														
Exterior handle HB 14-2, brushed stainless steel	●	●	●	●	●	●	●	●	●	●	○	○	○	
Exterior handle HB 38-2, brushed stainless steel	○	○	○	○	○	○	○	○	○	○	●	●	●	
<b>Door handle (interior)</b>														
Stainless steel lever handle	●	●	●	●	●	●	●	●	●	●	●	●	●	
<b>Rose escutcheon (exterior and interior)</b>														
Oval stainless steel profile cylinder rose escutcheons	●	●	●	●	●	●	●	●	●	●	●	●	●	
<b>Profile cylinder</b>														
Cylinder length 35.5 × 27.5 mm with 5 keys	●	●	●	●	●	●	●	●	●	●	●	●	●	
<b>Glazing frame</b>														
Round-style plastic, clipped				●	●	●	●							
Profile-style plastic, clipped With surface-mounted plastic rails									●	●				
Stainless steel, bonded											●	●	●	
<b>Glazing (for details on glass design, see style descriptions on pages 8 – 10)</b>														
<b>S</b> Insulated double glazing, Satinato				●	●	●	●							
<b>I</b> Insulated double glazing, cathedral glass small hammered finish									●	●				
<b>B</b> Insulated triple glazing, sand-blasted float with 7 clear stripes											●			
<b>C</b> Insulated triple glazing, sand-blasted float with 5 clear stripes												●		
<b>D</b> Insulated triple glazing, sand-blasted float with 4 clear stripes													●	
<b>Frames</b>														
• Aluminium block frame with aluminium / plastic threshold, with thermal break, colour matching the door leaf	●	●	●	●	●	●	●	●	●	●	●	●	●	
<b>Side element / transom light</b>														
• For doors opening inwards	○	○	○	○	○	○	○	○	○	○	○	○	○	

# Thermo46 entrance doors

## Entrance door programme

### Technical presentation of door set



#### TPS entrance doors with aluminium frame (profile A1 shown in the drawing)

Standard sizes		
Overall frame dimension Ordering size	Structural opening	Clear frame dimension
<b>1000 x 2100</b>	1020 x 2110	872 x 2016
<b>1100 x 2100</b>	1120 x 2110	972 x 2016
<b>1150 x 2200</b>	1170 x 2210	1022 x 2116

Special sizes		
TPS Styles	Overall frame dimension	
	Width	Height
010/020/030/ 040/700/750	700-1250	1875-2250
900	800-1250	1875-2250
015/025/515	875-1250	1875-2250
100/400	875-1100	1875-2186
200	875-1100	1990-2186

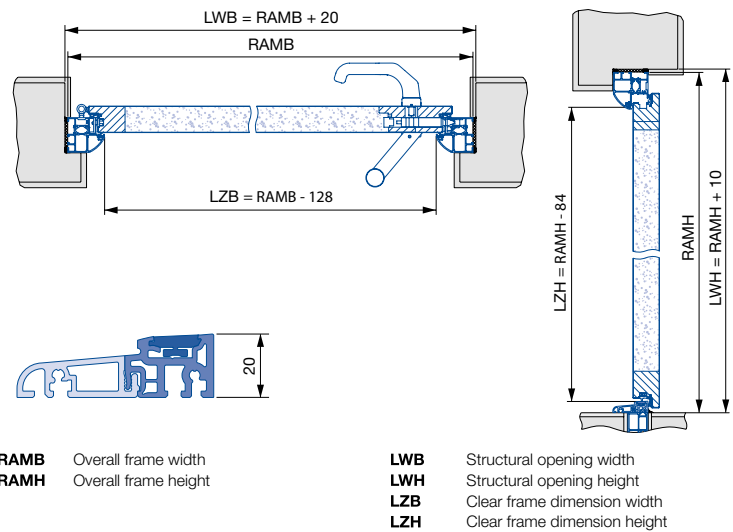

#### Wall connections for frames

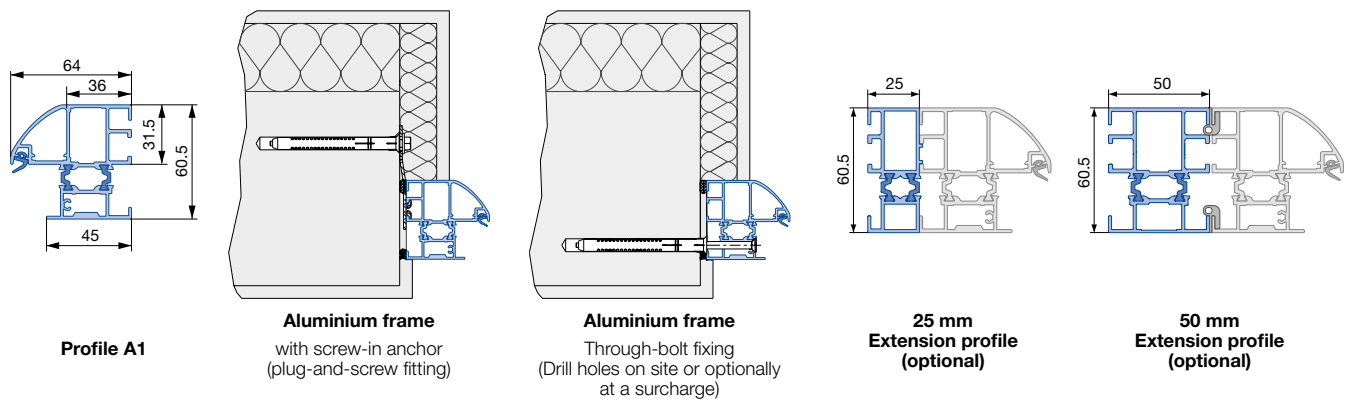

#### Wall connections for frames

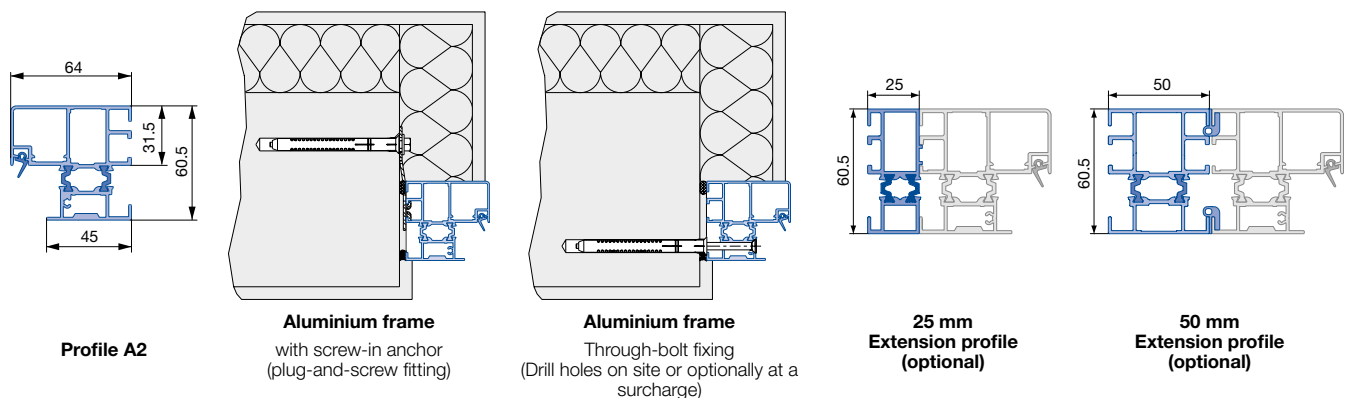

#### Retractable bottom seal (optional)

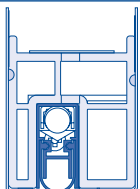

# Thermo46 entrance doors

Entrance door programme

Technical presentation of door set with side element / transom light



## TPS entrance doors with side element / transom light

Standard sizes – side element		
TPS Styles	Overall frame dimension	
	Width	Height
010/015/515/020/025/030/040/ 700/750/900/100/200/400	400	2100
	400	2200

Special sizes – side element		
TPS Styles	Overall frame dimension	
	Width	Height
010/015/515/040	See pages 22 and 23	
020/025/030/700/750/900		
100/200/400		

Size range – transom light		
TPS Styles	Overall frame dimension	
	Width	Height
All styles	See page 22	

Clear view		
	Width	Height
Side element	RAM side element – 116	RAM side element – 138
Transom light	RAM transom light – 116	RAM transom light – 116

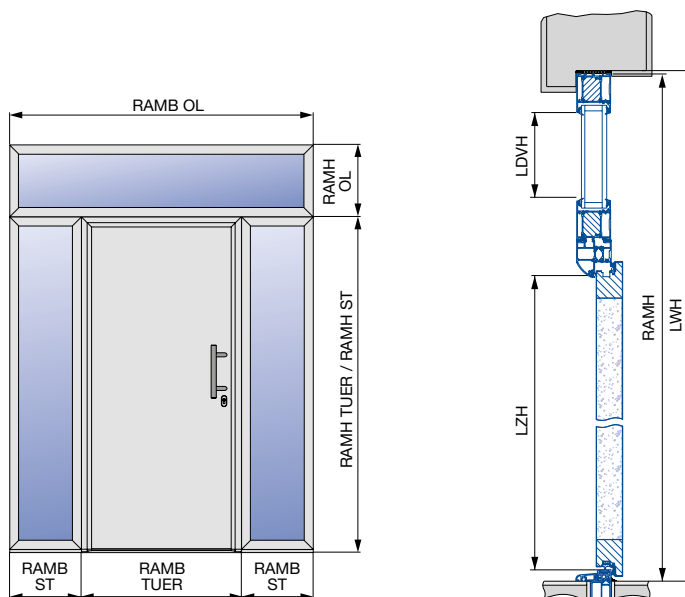
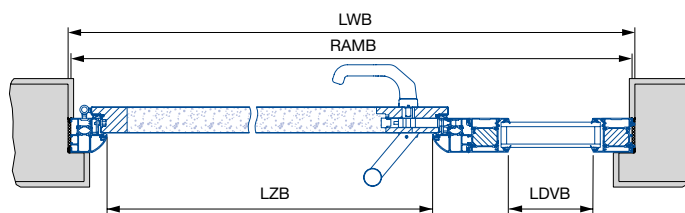
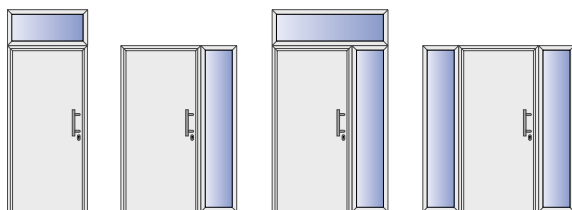

**RAMB** Overall frame width  
**RAMH** Overall frame height  
**TUER** Door  
**ST** Side element  
**OL** Transom light

**LWB** Structural opening width  
**LWH** Structural opening height  
**LZB** Clear frame dimension width  
**LZH** Clear frame dimension height  
**LDVB** Glazing clear view width  
**LDVH** Glazing clear view height



# Thermo46 entrance doors

Entrance door programme

Presentation of door set with glazing / ribbing



## Clear view for styles with glazing

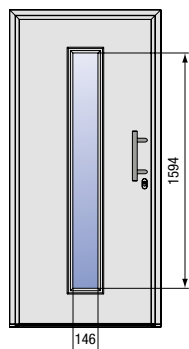

TPS 020S

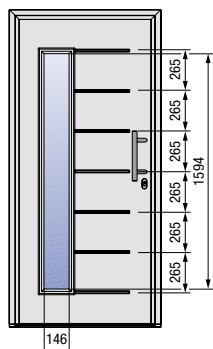

TPS 025S

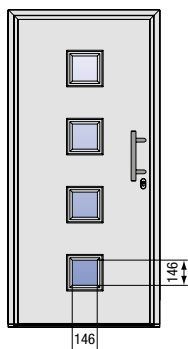

TPS 030S

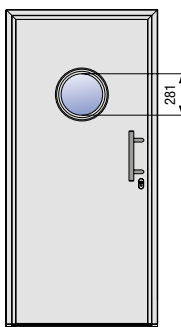

TPS 040S

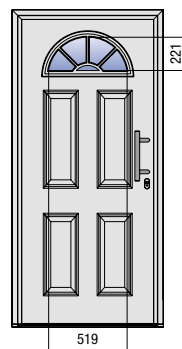

TPS 200I

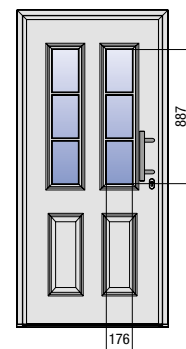

TPS 400I

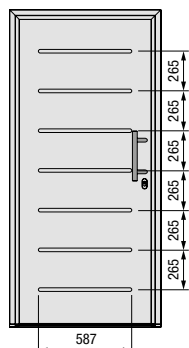

TPS 015

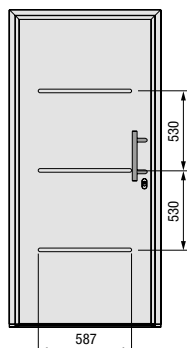

TPS 515

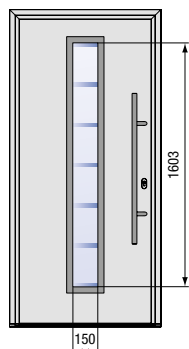

TPS 700B

Float glass sand-blasted with 7 clear horizontal stripes; stripes 35 mm high at the top, 20 mm in the centre, 35 mm at the bottom

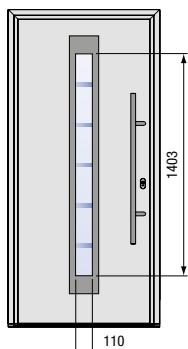
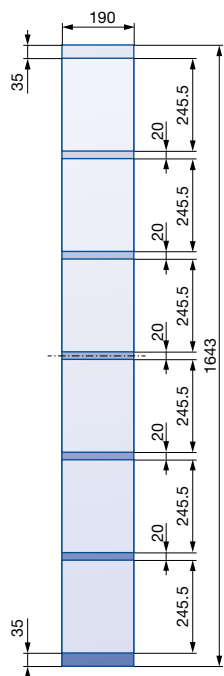

TPS 750C

Float glass sand-blasted with 5 clear horizontal stripes, each 20 mm high

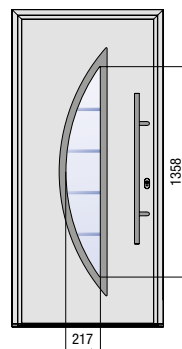
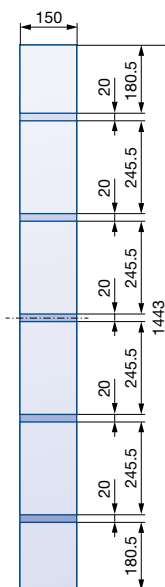

TPS 900D

Float glass sand-blasted with 4 clear horizontal stripes, each 20 mm high

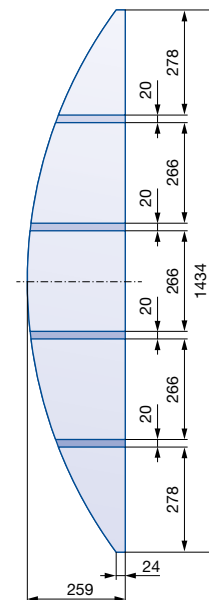

## Notes and sketches

---

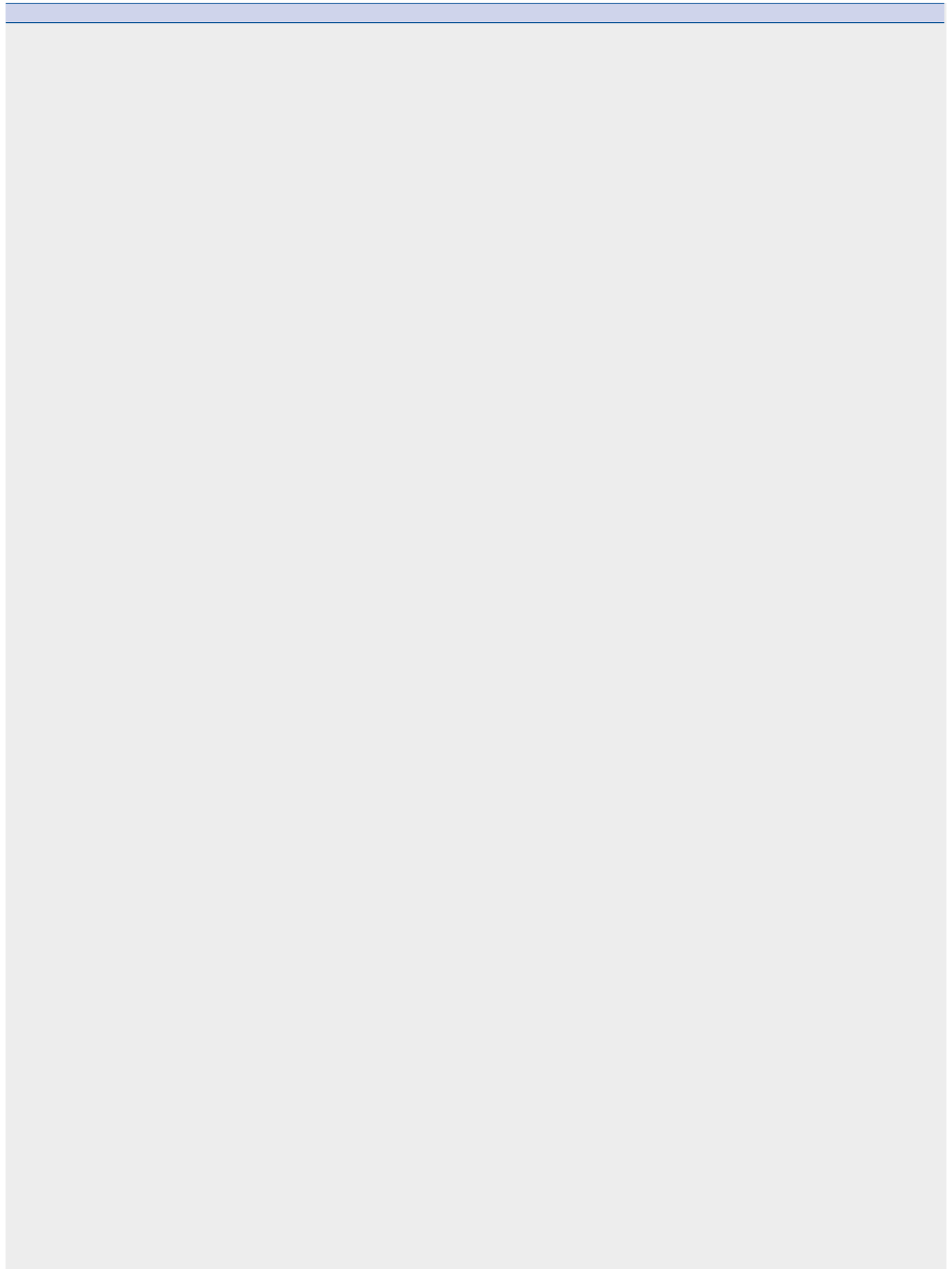

# Thermo46 entrance doors – steel

## Entrance door programme



For a product description, see from page 2

- Steel door leaf with thermal break overlapping the leaf, exterior and interior in the same colour
- Aluminium frame
- Multiple-point locking

**Preferred colour** 22 preferred colours (see page 2)

**Matt deluxe** 6 colours (see page 2)

**Decor** Golden Oak, Dark Oak, Night Oak, Winchester Oak and Titan Metallic CH 703

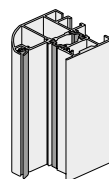

A1 profile

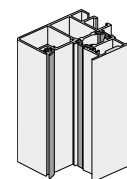

A2 profile

View	Style description	Size (RAM)	RAL 9016	Preferred colour	Matt deluxe	Decor
------	-------------------	------------	----------	------------------	-------------	-------

### Style TPS 010

- Smooth sheet
- Handle HB 14-2



		1000 × 2100 1100 × 2100 1150 × 2200	<b>1157</b>	<b>1282</b>	<b>1377</b>	<b>1406</b>
From	700 × 1875		<b>1543</b>	<b>1668</b>	<b>1763</b>	<b>1792</b>
Up to	1250 × 2250					

► U<sub>D</sub>-value for dimensions 1230 × 2180 mm: 1.1 W/(m<sup>2</sup>·K)

### Style TPS 015

- Ribbed sheet with 7 ribs (exterior)
- Handle HB 14-2



		1000 × 2100 1100 × 2100 1150 × 2200	<b>1205</b>	<b>1330</b>	<b>1425</b>	<b>1454</b>
From	875 × 1875		<b>1590</b>	<b>1715</b>	<b>1810</b>	<b>1839</b>
Up to	1250 × 2250					

► U<sub>D</sub>-value for dimensions 1230 × 2180 mm: 1.1 W/(m<sup>2</sup>·K)

### Style TPS 515

- Ribbed sheet with 3 ribs (exterior)
- Handle HB 14-2



		1000 × 2100 1100 × 2100 1150 × 2200	<b>1205</b>	<b>1330</b>	<b>1425</b>	<b>1454</b>
From	875 × 1875		<b>1590</b>	<b>1715</b>	<b>1810</b>	<b>1839</b>
Up to	1250 × 2250					

► U<sub>D</sub>-value for dimensions 1230 × 2180 mm: 1.1 W/(m<sup>2</sup>·K)

### Style TPS 020S

- Smooth sheet
- 2 panes of insulated glass, exterior laminated safety glass – interior single-pane safety glass Satinato
- Plastic glazing frame in door leaf colour (exception: decor surface finish\*)
- Handle HB 14-2



		1000 × 2100 1100 × 2100 1150 × 2200	<b>1417</b>	<b>1828</b>	<b>1925</b>	<b>1954</b>
From	700 × 1875		<b>1802</b>	<b>2213</b>	<b>2310</b>	<b>2339</b>
Up to	1250 × 2250					

► U<sub>D</sub>-value for dimensions 1230 × 2180 mm: 1.4 W/(m<sup>2</sup>·K)

### Style TPS 025S

- Ribbed sheet with 7 ribs (exterior)
- 2 panes of insulated glass, exterior laminated safety glass – interior single-pane safety glass Satinato
- Plastic glazing frame in door leaf colour (exception: decor surface finish\*)
- Handle HB 14-2



		1000 × 2100 1100 × 2100 1150 × 2200	<b>1499</b>	<b>1910</b>	<b>2007</b>	<b>2036</b>
From	875 × 1875		<b>1885</b>	<b>2296</b>	<b>2393</b>	<b>2422</b>
Up to	1250 × 2250					

► U<sub>D</sub>-value for dimensions 1230 × 2180 mm: 1.4 W/(m<sup>2</sup>·K)

\* For decor door surface finishes, the plastic glazing frames are coated in a colour matching the decor.

## Accessories and optional extras

See from page 11



# Thermo46 entrance doors – steel

## Entrance door programme



For a product description, see from page 2

- Steel door leaf with thermal break overlapping the leaf, exterior and interior in the same colour
- Aluminium frame
- Multiple-point locking

**Preferred colour** 22 preferred colours (see page 2)

**Matt deluxe** 6 colours (see page 2)

**Decor** Golden Oak, Dark Oak, Night Oak, Winchester Oak and Titan Metallic CH 703

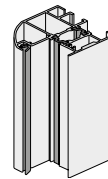



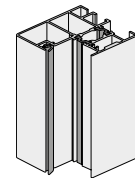

A1 profile



or

A2 profile

View	Style description	Size (RAM)	RAL 9016	Preferred colour	Matt deluxe	Decor
<b>Style TPS 030S</b>						
	<ul style="list-style-type: none"> <li>• Smooth sheet</li> <li>• 2 panes of insulated glass, exterior laminated safety glass – interior single-pane safety glass Satinato</li> <li>• Plastic glazing frame in door leaf colour (exception: decor surface finish*)</li> <li>• Handle HB 14-2</li> </ul>	1000 × 2100	<b>1642</b>	<b>2053</b>	<b>2150</b>	<b>2179</b>
		1100 × 2100				
		1150 × 2200				
		From 700 × 1875	<b>2028</b>	<b>2439</b>	<b>2536</b>	<b>2565</b>
		Up to 1250 × 2250				
▶ U <sub>D</sub> -value for dimensions 1230 × 2180 mm: 1.3 W/(m <sup>2</sup> ·K)						
<b>Style TPS 040S</b>						
	<ul style="list-style-type: none"> <li>• Smooth sheet</li> <li>• 2 panes of insulated glass, exterior laminated safety glass – interior single-pane safety glass Satinato</li> <li>• Plastic glazing frame in door leaf colour (exception: decor surface finish*)</li> <li>• Handle HB 14-2</li> </ul>	1000 × 2100	<b>1417</b>	<b>1828</b>	<b>1925</b>	<b>1954</b>
		1100 × 2100				
		1150 × 2200				
		From 700 × 1875	<b>1802</b>	<b>2213</b>	<b>2310</b>	<b>2339</b>
		Up to 1250 × 2250				
▶ U <sub>D</sub> -value for dimensions 1230 × 2180 mm: 1.2 W/(m <sup>2</sup> ·K)						
<b>Style TPS 100</b>						
	<ul style="list-style-type: none"> <li>• Panelled sheet (on both sides)</li> <li>• Handle HB 14-2</li> </ul>	1000 × 2100	<b>1205</b>	<b>1330</b>	<b>1425</b>	-
		1100 × 2100				
		From 875 × 1875				
		Up to 1100 × 2186	<b>1590</b>	<b>1715</b>	<b>1810</b>	-
▶ U <sub>D</sub> -value for dimensions 1230 × 2180 mm: 1.1 W/(m <sup>2</sup> ·K)						
<b>Style TPS 2001</b>						
	<ul style="list-style-type: none"> <li>• Panelled sheet (on both sides)</li> <li>• 2 panes of insulated glass, exterior single-pane safety glass – interior single-pane safety cathedral glass with small hammered finish</li> <li>• Plastic glazing frame with surface-mounted rails</li> <li>• Handle HB 14-2</li> </ul>	1000 × 2100	<b>1499</b>	<b>1910</b>	<b>2007</b>	-
		1100 × 2100				
		From 875 × 1990				
		Up to 1100 × 2186	<b>1885</b>	<b>2296</b>	<b>2393</b>	-
▶ U <sub>D</sub> -value for dimensions 1230 × 2180 mm: 1.2 W/(m <sup>2</sup> ·K)						
<b>Style TPS 4001</b>						
	<ul style="list-style-type: none"> <li>• Panelled sheet (on both sides)</li> <li>• 2 panes of insulated glass, exterior laminated safety glass – interior single-pane safety cathedral glass with small hammered finish</li> <li>• Plastic glazing frame with surface-mounted rails</li> <li>• Handle HB 14-2</li> </ul>	1000 × 2100	<b>1364</b>	<b>1775</b>	<b>1872</b>	-
		1100 × 2100				
		From 875 × 1875				
		Up to 1100 × 2186	<b>1750</b>	<b>2161</b>	<b>2258</b>	-
▶ U <sub>D</sub> -value for dimensions 1230 × 2180 mm: 1.4 W/(m <sup>2</sup> ·K)						

\* For decor door surface finishes, the plastic glazing frames are coated in a colour matching the decor.

**Accessories and optional extras**

See from page 11

# Thermo46 entrance doors – steel

## Entrance door programme



For a product description, see from page 2

- Steel door leaf with thermal break overlapping the leaf, exterior and interior in the same colour
- Aluminium frame
- Multiple-point locking

**Preferred colour** 22 preferred colours (see page 2)

**Matt deluxe** 6 colours (see page 2)

**Decor** Golden Oak, Dark Oak, Night Oak, Winchester Oak and Titan Metallic CH 703

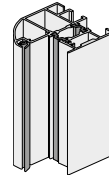

A1 profile

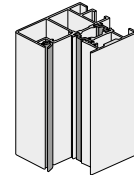

A2 profile

View	Style description	Size (RAM)	RAL 9016	Preferred colour	Matt deluxe	Decor
------	-------------------	------------	----------	------------------	-------------	-------

### Style TPS 700B



- Smooth sheet
- 3 panes of insulated glass, exterior laminated safety glass – sand-blasted float with 7 clear stripes – interior single-pane safety glass
- Stainless steel glazing frame
- Handle HB 38-2

		1000 × 2100				
		1100 × 2100	1642	1767	1862	1891
		1150 × 2200				
From	700 × 1875		2028	2153	2248	2277
Up to	1250 × 2250					

► U<sub>D</sub>-value for dimensions 1230 × 2180 mm: 1.2 W/(m<sup>2</sup>·K)

### Style TPS 750C



- Smooth sheet
- 3 panes of insulated glass, exterior laminated safety glass – sand-blasted float with 5 clear stripes – interior laminated safety glass
- Stainless steel glazing frame
- Handle HB 38-2

		1000 × 2100				
		1100 × 2100	1642	1767	1862	1891
		1150 × 2200				
From	700 × 1875		2028	2153	2248	2277
Up to	1250 × 2250					

► U<sub>D</sub>-value for dimensions 1230 × 2180 mm: 1.2 W/(m<sup>2</sup>·K)

### Style TPS 900D



- Smooth sheet
- 3 panes of insulated glass, exterior laminated safety glass – sand-blasted float with 4 clear stripes – interior single-pane safety glass
- Stainless steel glazing frame
- Handle HB 38-2

		1000 × 2100				
		1100 × 2100	1694	1819	1914	1943
		1150 × 2200				
From	800 × 1875		2079	2204	2299	2328
Up to	1250 × 2250					

► U<sub>D</sub>-value for dimensions 1230 × 2180 mm: 1.2 W/(m<sup>2</sup>·K)

\* For decor door surface finishes, the plastic glazing frames are coated in a colour matching the decor.

### Accessories and optional extras

See from page 11

# Thermo46 entrance doors

## Entrance door programme

### Accessories



Exterior door handles (included in door price)		£
	<p><b>Handle HB 14-2</b></p> <ul style="list-style-type: none"> <li>Brushed stainless steel</li> <li>Standard with styles TPS 010, TPS 015, TPS 020, TPS 025, TPS 030, TPS 040, TPS 100, TPS 200, TPS 400 and TPS 515</li> </ul>	<p>Surcharge for conversion to handle HB 14-2</p> <p><b>137</b></p>
	<p><b>Handle HB 38-2</b></p> <ul style="list-style-type: none"> <li>Brushed stainless steel</li> <li>Standard with styles TPS 700, TPS 750 and TPS 900</li> </ul>	<p>Surcharge for conversion to handle HB 38-2</p> <p><b>137</b></p>
	<p><b>Handle HB 38-3</b></p> <ul style="list-style-type: none"> <li>Brushed stainless steel</li> </ul>	<p>Surcharge for conversion to handle HB 38-3</p> <p><b>137</b></p>
Rose escutcheon		Surcharges £
	<p><b>Exterior oval rose escutcheon</b> (screwed)</p>	<p>Each <b>50</b></p>
ES 0 fittings Including profile cylinder with 5 keys		Surcharges £
	<p>Knob / lever handle</p>	<p>Stainless steel</p> <p>Each <b>137</b></p>
	<p>Lever handle / lever handle</p>	<p>Stainless steel</p> <p>Each <b>137</b></p>
ES 1 fittings Including profile cylinder with 5 keys		Surcharges £
<p><b>Note:</b> ES 1 fittings are only possible from a RAM of 900 mm for style TPS 400.</p>		
	<p>Knob / lever handle</p>	<p>Stainless steel</p> <p>Each <b>220</b></p>
	<p>Lever handle / lever handle</p>	<p>Stainless steel</p> <p>Each <b>220</b></p>



# Thermo46 entrance doors

## Entrance door programme

### Accessories



#### Rose escutcheons Including profile cylinder with 5 keys Surcharges £

**Note:**

The rose escutcheons are only possible from a RAM width of 900 mm for the style TPS 400.

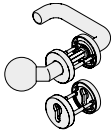
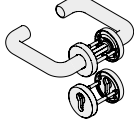
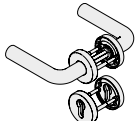
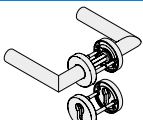
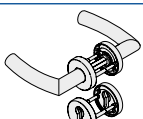
	Knob K-160 / lever handle, type D-110	Stainless steel	Each	<b>137</b>
	Lever handle / lever handle, type D-110	Stainless steel	Each	<b>137</b>
	Lever handle / lever handle, type D-210	Stainless steel	Each	<b>137</b>
	Lever handle / lever handle, type D-310	Stainless steel	Each	<b>137</b>
	Lever handle / lever handle, type D-510	Stainless steel	Each	<b>137</b>

#### Calculation example

£

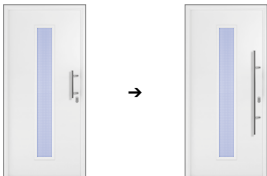
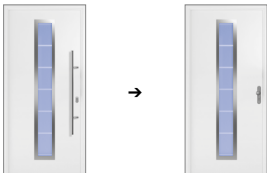
<b>Conversion TPS 020 with HB 14-2 to HB 38-2</b>		Style TPS 020 in RAL 9016 with profile A1 (standard size)	<b>1417</b>
		+ Conversion from handle HB 14-2 to handle HB 38-2	<b>137</b>
		= Total	<b>1554</b>
<b>Conversion TPS 700 with HB 38-2 to Fitting ES 1</b>		Style TPS 700 in RAL 9016 with profile A1 (standard size)	<b>1642</b>
		+ Surcharge for ES 1 stainless steel knob / lever handle fitting	<b>220</b>
		= Total	<b>1862</b>

#### Advanced handle and letter plate

#### Silver aluminium sleeved letter plate

**52**

#### Accessories

**surcharge**

£

#### Prepared for letter drop

(TPS 010, 015, 040, 100, 200, 400, 515)

per door

**43**

#### Glazing separative horizontal rail in the side element (only in RAL 9016 and Colour)



#### Rail in the side element (not milled)

per side element

**231**

- Glazing separative horizontal rail

#### Rail in the side element (milled)

per side element

**273**

- Glazing separative horizontal rail
- milled for installation of a letter plate from size ≥ 450 mm (width)

# Thermo46 entrance doors

## Entrance door programme

### Accessories



<b>Emergency exit lock acc. to EN 179</b>	<b>Surcharges</b>	<b>£</b>
---	-------------------	----------

**Note:**

The rose escutcheons are only possible from a RAM width of 900 mm for the style TPS 400.

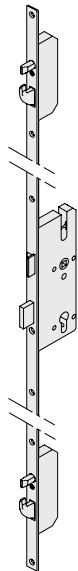

**Multiple-point locking with anti-panic function E**

- Anti-panic lock with stainless steel lock cover, distance 92 mm
- for the size range 1990 – 2250 mm

Each **174**

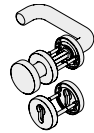

**Lever / knob handle set, rose escutcheon prepared for profile cylinder**

Black plastic Each **142**

Anodised aluminium (F1) Each **221**

**Knob K-130 / lever handle, type D-110**

Brushed stainless steel Each **286**

**Multiple-point locking with passage function D**

- Anti-panic lock with stainless steel lock cover, distance 92 mm
- for the size range 1990 – 2250 mm

Each **239**

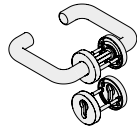

**Anti-panic lever handle set with split spindle, rose escutcheon prepared for profile cylinder**

Black plastic Each **142**

Anodised aluminium (F1) Each **221**

Brushed stainless steel Each **286**

**Lever handle / lever handle, type D-110**

**Multiple-point locking with change-over function B**

- Anti-panic lock with stainless steel lock cover, distance 92 mm
- for the size range 1990 – 2250 mm

Each **239**

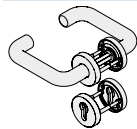

**Anti-panic lever handle set with split spindle, rose escutcheon prepared for profile cylinder**

Black plastic Each **142**

Anodised aluminium (F1) Each **221**

Brushed stainless steel Each **286**

**Lever handle / lever handle, type D-110**

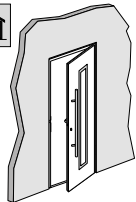

**Door set opening outwards**

(all approved characteristics will no longer apply!)

Per door **81**

**Escape door function acc. to DIN EN 179**

Emergency exit lock acc. to DIN EN 179

**Surcharge see above**

Optional escape door function (capacity for release) must be stated with the order

**No surcharge**

# Thermo46 entrance doors

## Entrance door programme

### Accessories



Profile cylinder			£
Profile cylinder (35.5 + 27.5 mm) For HB 14-2, HB 38-2 and HB 38-3 push bars	With 8 keys	Each	<b>74</b>
	With 10 keys	Each	<b>92</b>
Profile cylinder (40.5 + 31.5 mm) For ES 0 fittings	With 5 keys	Each	<b>48</b>
	With 8 keys	Each	<b>74</b>
	With 10 keys	Each	<b>92</b>
Profile cylinder (40.5 + 31.5 mm) with drilling and pull-off protection and security card For fittings ES 1 and push bar with security rose escutcheon ES 1	With 5 keys	Each	<b>83</b>
	With 8 keys	Each	<b>109</b>
	With 10 keys	Each	<b>127</b>
Profile cylinder (37.5 + 27.5 mm) For rose escutcheons	With 5 keys	Each	<b>48</b>
Profile cylinder, keys to pass for push bar or fittings ES 0	With 5 keys	Each	<b>48</b>
	With 8 keys	Each	<b>74</b>
	With 10 keys	Each	<b>92</b>
Profile cylinder, keys to pass, with drilling and pull-off protection and security card for ES 1 fittings	With 5 keys	Each	<b>83</b>
	With 8 keys	Each	<b>109</b>
	With 10 keys	Each	<b>127</b>

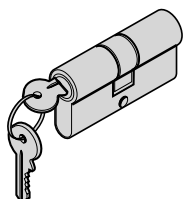

**Note:**  
No keys to pass for the profile cylinder from the fitting pack!

**Note:**  
No keys to pass for the profile cylinder from the fitting pack!

Door leaf and frame in different colours / surface finishes				
Colours of door leaf and frame do not match		Door leaf	Frame	Price for entrance door with surface finish
<p>Example</p> <p>Door leaf Anthracite grey</p> <p>Frame Traffic white</p>	RAL 9016	Preferred colour	<b>Preferred colour</b>	
	RAL 9016	Matt deluxe	<b>Matt deluxe</b>	
	RAL 9016	Decor	<b>Decor</b>	
	Preferred colour	RAL 9016	<b>Preferred colour</b>	
	Preferred colour	Preferred colour	<b>Preferred colour</b>	
	Preferred colour	Matt deluxe	<b>Matt deluxe</b>	
	Preferred colour	Decor	<b>Decor</b>	
	Matt deluxe	RAL 9016	<b>Matt deluxe</b>	
	Matt deluxe	Preferred colour	<b>Matt deluxe</b>	
	Matt deluxe	Matt deluxe	<b>Matt deluxe</b>	
	Matt deluxe	Decor	<b>Decor</b>	
	Decor	RAL 9016	<b>Decor</b>	
	Decor	Matt deluxe	<b>Decor</b>	
	Decor	Preferred colour	<b>Decor</b>	
Decor	Decor	<b>Decor</b>		

Retractable bottom seal		£
<p><b>Retractable bottom seal</b> (Frame without threshold)</p> <p><b>Notes:</b></p> <ul style="list-style-type: none"> <li>• Possible from RAM width 782 mm.</li> <li>• The performance characteristics thermal insulation (<math>U_D</math>) and water-tightness under heavy rain are limited!</li> </ul>	Each	<b>305</b>



# Thermo46 entrance doors

## Entrance door programme

### Accessories

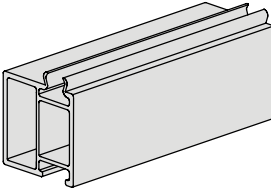
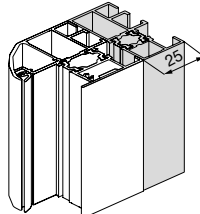
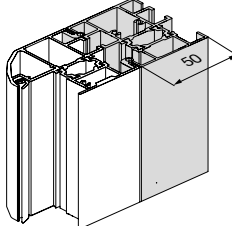
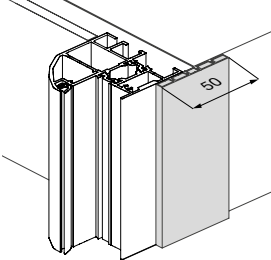
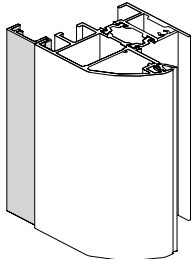

Profiles						£
	<b>Bottom spacer profile</b>	Length up to 1250 mm	Height 30 mm	Each	<b>28</b>	
			Height 60 mm	Each	<b>55</b>	
			Height 90 mm	Each	<b>83</b>	
			Height 120 mm	Each	<b>110</b>	
			Height 150 mm	Each	<b>138</b>	
		Length up to 2250 mm	Height 30 mm	Each	<b>46</b>	
			Height 60 mm	Each	<b>91</b>	
			Height 90 mm	Each	<b>136</b>	
			Height 120 mm	Each	<b>181</b>	
			Height 150 mm	Each	<b>226</b>	
		Length up to 3250 mm	Height 30 mm	Each	<b>65</b>	
			Height 60 mm	Each	<b>130</b>	
			Height 90 mm	Each	<b>195</b>	
			Height 120 mm	Each	<b>260</b>	
			Height 150 mm	Each	<b>325</b>	
	<b>Extension profile 25 mm</b> Dimensions (W x D): 25 x 60.5 mm	RAL 9016	Per m	<b>57</b>		
		Preferred colour	Per m	<b>69</b>		
		Matt deluxe	Per m	<b>80</b>		
		Golden Oak, Dark Oak, Night Oak, Winchester Oak, Titan Metallic CH 703	Per m	<b>80</b>		
	<b>Extension profile 50 mm</b> Dimensions (W x D): 50 x 60.5 mm	RAL 9016	Per m	<b>63</b>		
		Preferred colour	Per m	<b>74</b>		
		Matt deluxe	Per m	<b>85</b>		
		Golden Oak, Dark Oak, Night Oak, Winchester Oak, Titan Metallic CH 703	Per m	<b>85</b>		
	<b>Cover profile</b> Per package 2 x 2300 mm and 1 x 1300 mm Dimensions (W x D): 50 x 5 mm Profiles sufficient for a door without side elements / transom light.	RAL 9016	Per box	<b>129</b>		
		Golden Oak, Dark Oak, Night Oak, Winchester Oak, Titan Metallic CH 703	Per box	<b>173</b>		
	<b>Supplementary profile (on 3 sides)</b> Width 20 mm, mitred, incl. corner bracket and fitting screws	RAL 9016	Per door	<b>265</b>		
		Preferred colour	Per door	<b>333</b>		
		Matt deluxe	Per door	<b>345</b>		
		Golden Oak, Dark Oak, Titan Metallic CH 703	Per door	<b>345</b>		

# Thermo46 entrance doors

## Entrance door programme

### Accessories



Door closers		£	
	<b>Reinforcement in door leaf for door closer</b>	Each <b>32</b>	
	<b>Door closer HDC 35 for fitting on opening side (hinge side)</b> For aluminium frame profile A1 or A2	Each <b>188</b>	
	<b>Door closer HDC 35 for fitting on closing side (opposite hinge side)</b> For aluminium frame profile A2	Each <b>188</b>	
	<b>Mechanical hold-open device</b>	Each <b>74</b>	
<b>Accessories</b>		<b>£</b>	
	<b>Electric strike with day catch</b> (separate)	Each <b>87</b>	
	<b>Reed contact</b> (separate), door leaf and frame prepared	Each <b>109</b>	
	<b>Door set opening outwards</b> (all approved characteristics will no longer apply!)	Per door <b>81</b>	
	<b>Spyhole (fitted)</b> (only for TPS 010, TPS 015, TPS 100, TPS 200, TPS 400 and TPS 515)	Each <b>54</b>	
	<b>Spyhole, with thermal break (fitted)</b> (only for TPS 010, TPS 015, TPS 100, TPS 200, TPS 400 and TPS 515)	Each <b>109</b>	
	<b>Rain canopy</b> Anodised aluminium	Each <b>26</b>	
	<b>Door drip</b> (aluminium painted)	RAL 9016 Traffic white	Each <b>37</b>
		Stainless steel look	Each <b>55</b>
	<b>Door drip</b>	Stainless steel	Each <b>227</b>
	<b>Stainless steel cleaner and care product</b> (150 ml)	Each <b>35</b>	

# Thermo46 entrance doors

## Entrance door programme

### Accessories



#### Accessories £

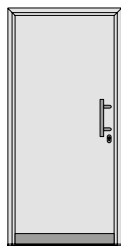

##### Stainless steel bottom sheet on the exterior (separate)

- Bottom sheet height 110 mm
- Size range of heights for style

Style	Height (RAM)
TPS 010 / TPS 040	1875 – 2250 mm
TPS 015 / TPS 020 / TPS 025 / TPS 030 / TPS 100 / TPS 200 / TPS 400 / TPS 515 / TPS 700 / TPS 750 / TPS 900	2050 – 2250 mm

Per door **193**

##### Notes:

- Not in combination with embellishments in stainless steel look, view 451, 454, 457, 459, 750 and 751.
- Not in conjunction with the door drip.

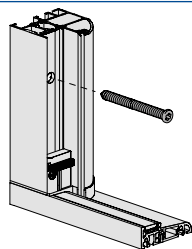

##### // NEW

##### Through-bolt fixing (4 fitting holes for each side bar)

For aluminium frame profile A1 and A2

Per door **81**

#### Fixing material £

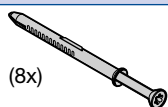

(8x)

##### Plug-and-screw set

8 x screws and 8 x plugs, 8 x 120 mm

Per set **26**

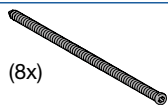

(8x)

##### Frame screws

8 x frame screws 7.5 x 182 mm

Per set **26**

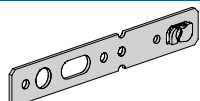

##### Screw-in anchor set

Length 280 mm (8 x anchors)

Per set **31**

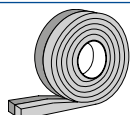

##### Pre-compressed sealing strip (56 mm wide) for groove widths from 6 – 15 mm

(for fitting using state-of-the-art technology)

Per roll **95**

# Thermo46 entrance doors

## Entrance door programme

### Accessories



#### Entrance door in RC 2 version (for a product description, see page 2) £

##### Hook bolt lock: attack side = closing side (opposite hinge side)

RC 2		Package HB 14-2 with security rose escutcheon	Stainless steel	Per door	<b>142</b>
		Package HB 38-2 with security rose escutcheon	Stainless steel	Per door	<b>142</b>
		Package HB 38-3 with security rose escutcheon	Stainless steel	Per door	<b>142</b>
		ES 1 fittings	Knob / lever handle	Stainless steel	Per door
		Lever handle / lever handle	Stainless steel	Per door	<b>220</b>
RC 2		Package HB 14-2 with security rose escutcheon and safety glass (P4A)	Stainless steel	Per door	<b>261</b>
		Package HB 38-2 with security rose escutcheon and safety glass (P4A)	Stainless steel	Per door	<b>261</b>
		Package HB 38-3 with security rose escutcheon and safety glass (P4A)	Stainless steel	Per door	<b>261</b>
		Fittings ES 1 and safety glass (P4A)	Knob / lever handle	Stainless steel	Per door
		Lever handle / lever handle	Stainless steel	Per door	<b>339</b>

#### Approved size range for RC 2 version for each style

	<p>TPS 010    TPS 700    TPS 750    TPS 900</p>	<p>TPS 100</p>	<p>TPS 015    TPS 515</p>
<b>Width</b>	832 – 1250	875 – 1100	875 – 1250
<b>Height</b>	1875 – 2250	1875 – 2186	1875 – 2250

#### Example for calculating an entrance door as an RC 2 version £

<p><b>Conversion</b>  <b>TPS 700 with HB 38-2</b>  <b>to</b>  <b>Package HB 38-2 with security</b>  <b>rose escutcheon</b></p>		<p>Style TPS 700 in RAL 9016 with profile A1 (standard size) <b>1642</b></p> <p>+ Conversion for package HB 38-2 with security rose escutcheon <b>261</b></p> <p>= Total <b>1903</b></p>
--	--	--

#### Secured By Design option £



Secured by Design in conjunction with the Association of Chief Police Officers, is a security upgrade to help combat crime. The fully accredited door will come supplied with a high security cylinder complete with registration card and 3 security keys.

Available on styles 100, 700, 900, 010, 030, 040 and 015

**127**

# Thermo46 entrance doors

Entrance door programme

Accessories

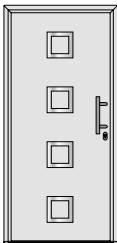
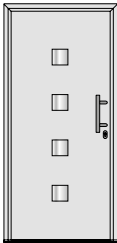
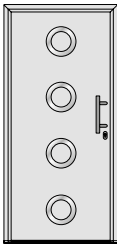
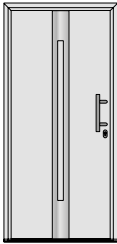
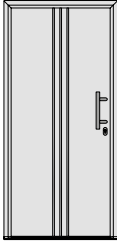

Embellishments for style TPS 010 (on the exterior)			Surcharge	£	
	<b>View 451</b>	<b>Stainless steel frames</b> Overall dimension 240 × 240 mm Inside dimension 160 × 160 mm ▷ From RAM height 2000 mm	Style TPS 010	Per door	261
	<b>View 454</b>	<b>Stainless steel frames</b> Overall dimension 145 × 145 mm ▷ From RAM height 2000 mm	Style TPS 010	Per door	261
	<b>View 457</b>	<b>Curved stainless steel frames</b> ▷ From RAM height 2000 mm	Style TPS 010	Per door	261
	<b>View 459</b>	<b>Stainless steel rings</b> Overall dimension Ø 240 mm Inside dimension Ø 160 mm ▷ From RAM height 2000 mm	Style TPS 010	Per door	261
	<b>View 750</b>	<b>Stainless steel frame over entire leaf height</b> ▷ From RAM height 2000 mm	Style TPS 010	Per door	261
	<b>View 751</b>	<b>3 parallel stainless steel strips over the entire leaf height</b> ▷ From RAM height 2000 mm	Style TPS 010	Per door	261

# Thermo46 entrance doors

## Entrance door programme

### Accessories



#### Embellishments (on the exterior)

£

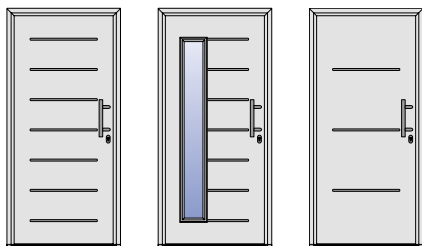

TPS 015

TPS 025

TPS 515

#### Embellishment in stainless steel look, view 400

- Inlay length 577 mm per rib for styles TPS 015 and 515
- Inlay length 351 mm per rib for style TPS 025

Style TPS 015 Per door **204**

Style TPS 025 Per door **204**

Style TPS 515 Per door **135**

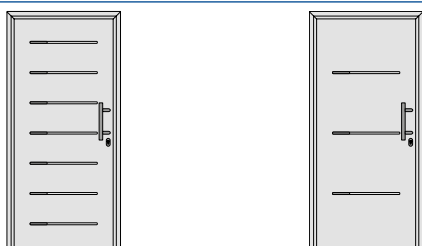

TPS 015

TPS 515

#### Embellishment in stainless steel look, view 401

Inlay length 118 mm per rib

Style TPS 015 Per door **204**

Style TPS 515 Per door **135**

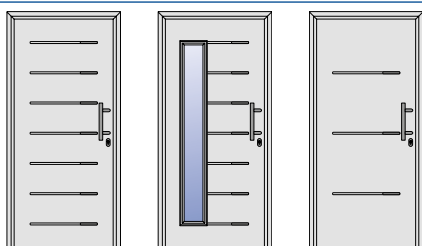

TPS 015

TPS 025

TPS 515

#### Embellishment in stainless steel look, view 402

Inlay length 118 mm per rib

Style TPS 015 Per door **204**

Style TPS 025 Per door **204**

Style TPS 515 Per door **135**

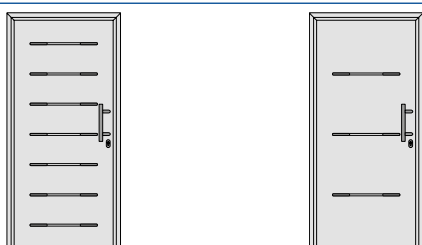

TPS 015

TPS 515

#### Embellishment in stainless steel look, view 403

Inlay length 2 x 118 mm per rib

Style TPS 015 Per door **204**

Style TPS 515 Per door **135**



## Notes and sketches

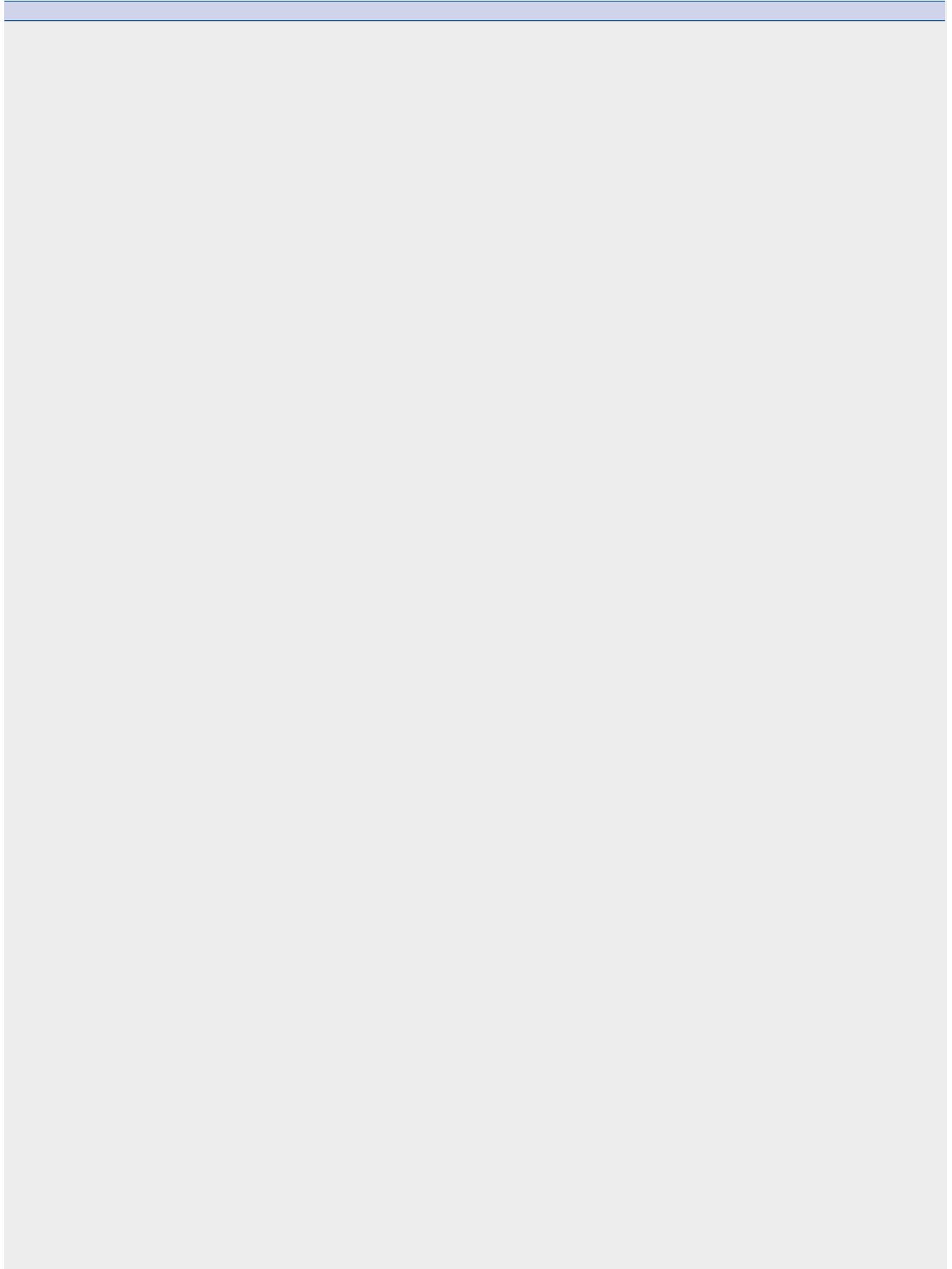

# Thermo46 entrance doors

## Entrance door programme

### Side elements and transom lights



#### Side element

##### Fixed side element assembly

###### Note:

- Not possible for door assemblies opening outwards!
- Not possible in conjunction with RC 2!

##### Standard size

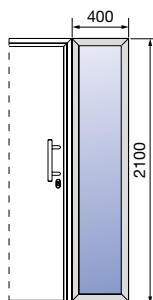

Ordering sizes RAM (mm) Width x height	Glass	RAL 9016	Preferred colour	Matt deluxe	Decor
400 x 2100 400 x 2200	Clear	831	963	1051	1006
	Satinato	831	963	1051	1006
	Cathedral glass	831	963	1051	1006
	Sand-blasted	831	963	1051	1006
	Sand-blasted with clear stripes	1400	1532	1620	1575

#### Side element

##### Fixed side element assembly

###### Note:

- Not possible for door assemblies opening outwards!
- Not possible in conjunction with RC 2!

##### Special sizes

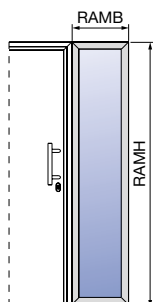

Ordering sizes RAM up to (mm) Width x height	Glass	RAL 9016	Preferred colour	Matt deluxe	Decor
From 300 x 700 Up to 500 x 2250	Clear, Satinato, cathedral glass or sand-blasted according to overview on page 23	1031	1163	1251	1206
Up to 1000 x 2250 *		1228	1360	1448	1403
From 300 x 1875 Up to 500 x 2250	Sand-blasted with clear stripes according to overview on page 23	1747	1879	1967	1922
Up to 1000 x 2250 *		1942	2074	2162	2117

\* Only possible without transom light  
Door set with side element does not contribute to the static equilibrium. Statics must be ensured by the building structure.

#### Transom light

##### Fixed transom light assembly

###### Note:

- Not possible for door assemblies opening outwards!
- Not possible in conjunction with RC 2!

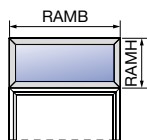

Ordering sizes RAM (mm) Width x height	Glass	RAL 9016	Preferred colour	Matt deluxe	Decor
From 700 x 300 Up to 1250 x 500	Clear, Satinato, cathedral glass or sand-blasted according to overview on page 23	782	914	1002	957
Up to 2250 x 500		1034	1166	1254	1209

**RAMB** = Overall frame width

**RAMH** = Overall frame height

# Thermo46 entrance doors



## Entrance door programme

### Overview of panels / glass for side elements

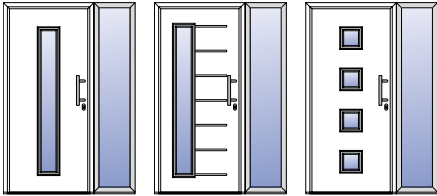
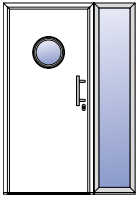

#### Infill / size range

#### Glass design: Exterior pane clear laminated safety glass – interior pane

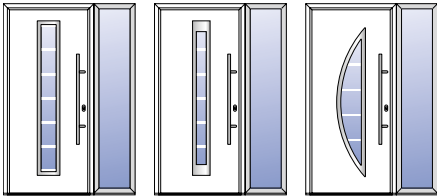
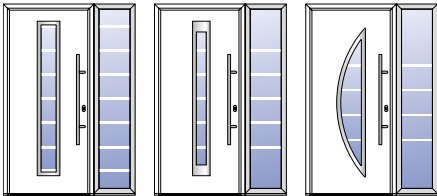
	Style	Glass (Interior pane)	Size range	
			Side element	Transom light
"Modern" type A	 <p>TPS 010    TPS 015    TPS 515</p>	<ol style="list-style-type: none"> <li>Satinato single-pane safety glass</li> <li>Sand-blasted laminated safety glass (without clear stripes)</li> <li>Laminated safety glass, clear</li> <li>Cathedral single-pane safety glass</li> </ol>	<p><b>Width</b> 300 – 1000 mm</p> <p><b>Height</b> 700 – 2250 mm</p>	<p><b>Width</b> 700 – 2250 mm</p> <p><b>Height</b> 300 – 500 mm</p>
	 <p>TPS 020    TPS 025    TPS 030</p>	<ol style="list-style-type: none"> <li>Satinato single-pane safety glass</li> <li>Laminated safety glass, clear</li> </ol>	<p><b>Width</b> 300 – 1000 mm</p> <p><b>Height</b> 700 – 2250 mm</p>	<p><b>Width</b> 700 – 2250 mm</p> <p><b>Height</b> 300 – 500 mm</p>
	 <p>TPS 040</p>	<ol style="list-style-type: none"> <li>Satinato single-pane safety glass</li> <li>Laminated safety glass, clear</li> </ol>	<p><b>Width</b> 300 – 1000 mm</p> <p><b>Height</b> 700 – 2250 mm</p>	<p><b>Width</b> 700 – 2250 mm</p> <p><b>Height</b> 300 – 500 mm</p>
"Classic"	 <p>TPS 100    TPS 200    TPS 400</p>	<ol style="list-style-type: none"> <li>Cathedral single-pane safety glass</li> <li>Laminated safety glass, clear</li> </ol>	<p><b>Width</b> 300 – 1000 mm</p> <p><b>Height</b> 700 – 2186 mm</p>	<p><b>Width</b> 875 – 2100 mm</p> <p><b>Height</b> 300 – 500 mm</p>
"Modern" type B	 <p>TPS 700    TPS 750    TPS 900</p>	<ol style="list-style-type: none"> <li>Sand-blasted laminated safety glass (without clear stripes)</li> <li>Laminated safety glass, clear</li> </ol>	<p><b>Width</b> 300 – 1000 mm</p> <p><b>Height</b> 700 – 2250 mm</p>	<p><b>Width</b> 700 – 2250 mm</p> <p><b>Height</b> 300 – 500 mm</p>
	 <p>TPS 700    TPS 750    TPS 900</p>	<ol style="list-style-type: none"> <li>Sand-blasted laminated safety glass with clear stripes (only in side element)</li> </ol>	<p><b>Width</b> 300 – 1000 mm</p> <p><b>Height</b> 1875 – 2250 mm</p>	<p><b>Width</b> 700 – 2250 mm</p> <p><b>Height</b> 300 – 500 mm</p>

# Thermo65 entrance doors

## Entrance door programme

### Product description



- Standard
- Optional

Product description		Thermo65 – steel THP																																																											
		010	015	515	100	410S	430E	600S	610S	700B/N	730B	750C	800S	810E/N	820S	830S	840S	850B	900D																																										
<b>Door leaf structure</b>																																																													
Smooth sheet		●						●	●	●	●	●	●	●	●	●	●	●	●																																										
Ribbed sheet (exterior)			●	●																																																									
Panelled sheet (on both sides)					●	●	●																																																						
Door leaf thickness		65 mm thick																																																											
Sheet thickness		0.6 – 0.8 mm																																																											
Fully foamed, with thermal break, Exterior and interior overlapping the leaf		●	●	●	●	●	●	●	●	●	●	●	●	●	●	●	●	●	●																																										
<b>Size ranges (see also page 30)</b>																																																													
Standard sizes (RAM)		1000 × 2100 mm and 1100 × 2100 mm																																																											
Special sizes (RAM)	700 – 1250 mm Width	●						●	●	●	●	●	●	●																																															
	1875 – 2250 mm Height																																																												
	800 – 1250 mm Width																																																												
	1875 – 2250 mm Height														●				●	●																																									
Special sizes (RAM)	875 – 1250 mm Width		●	●																																																									
	1875 – 2250 mm Height																																																												
	875 – 1100 mm Width				●	●	●																																																						
	1875 – 2186 mm Height																																																												
<b>Surface finish</b>																																																													
<b>Note:</b> For doors with dark surfaces, the material expansion is particularly high. Therefore, please check the location of the door in the building during consultation. This will ensure trouble-free door operation.																																																													
<b>Standard</b>																																																													
<ul style="list-style-type: none"> <li>● Traffic white, based on RAL 9016</li> <li>● Painted on both sides</li> <li>● Silk matt, gloss level 35 – 40 %</li> </ul>		●	●	●	●	●	●	●	●	●	●	●	●	●	●	●	●	●	●	●																																									
<b>Preferred colour</b>																																																													
<ul style="list-style-type: none"> <li>● 22 preferred colours</li> <li>● Painted on both sides, based on the RAL colour chart</li> <li>● Silk matt, gloss level 35 – 40 %</li> </ul>		RAL 1015 Light ivory			RAL 3000 Flame red			RAL 3003 Ruby red			RAL 3004 Purple red			RAL 5010 Gentian blue			RAL 5014 Pigeon blue			RAL 6005 Moss green			RAL 7012 Basalt grey			RAL 7015 Slate grey			RAL 7016 Anthracite grey			RAL 7037 Dusty grey			RAL 7035 Light grey			RAL 7039 Quartz grey			RAL 7040 Window grey			RAL 8003 Clay brown			RAL 8028 Terra brown			RAL 9001 Cream			RAL 9002 Grey white			RAL 9006 White aluminium			RAL 9007 Grey aluminium		
<b>Matt deluxe</b>																																																													
<ul style="list-style-type: none"> <li>● 6 colours</li> <li>● Painted on both sides</li> <li>● matt, gloss level 3 – 8 %</li> </ul>		●	●	●	●	●	●	●	●	●	●	●	●	●	●	●	●	●	●	●																																									
		CH 9016 Matt deluxe, Traffic white			CH 8028 Matt deluxe, Terra brown			CH 7016 Matt deluxe, Anthracite grey			CH 9006 Matt deluxe, White aluminium			CH 9007 Matt deluxe, Grey aluminium			CH 703 Matt deluxe, Anthracite metallic																																												
<b>Decor</b>																																																													
Film coating, on both sides																																																													
Golden Oak		●	●	●					●		●	●	●	●	●	●	●	●	●																																										
Dark Oak		●	●	●					●		●	●	●	●	●	●	●	●	●																																										
Night Oak		●	●	●					●		●	●	●	●	●	●	●	●	●																																										
Winchester Oak		●	●	●					●		●	●	●	●	●	●	●	●	●																																										
Titan Metallic CH 703		●	●	●					●		●	●	●	●	●	●	●	●	●																																										
<b>Seals</b>																																																													
Door leaf: 4-sided, double seals		●	●	●	●	●	●	●	●	●	●	●	●	●	●	●	●	●	●																																										
Frame: 3-sided seals		●	●	●	●	●	●	●	●	●	●	●	●	●	●	●	●	●	●																																										
<b>Lock</b>																																																													
Multiple-point locking with main lock (with soft lock latch) and 2 bolts, swing / hook bolt combination, main lock plate with adjustable latch slot, secondary lock plates with eccentric adjustment		●	●	●	●	●	●	●	●	●	●	●	●	●	●	●	●	●	●																																										
<b>Electric strikes</b>																																																													
Electric strike with day catch (separate)		○	○	○	○	○	○	○	○	○	○	○	○	○	○	○	○	○	○																																										
<b>Security bolts</b>																																																													
Safety strip on the hinge side		●	●	●	●	●	●	●	●	●	●	●	●	●	●	●	●	●	●																																										

# Thermo65 entrance doors

## Entrance door programme

## Product description

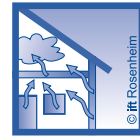

- Standard
- Optional

Product description	Thermo65 – steel THP																	
	010	015	515	100	410S	430E	600S	610S	700B/N	730B	750C	800S	810E/N	820S	830S	840S	850B	900D
<b>Frames</b>																		
Aluminium block frame with thermal break (colour matching the door leaf) with aluminium / plastic threshold with thermal break (subsequent replacement possible)	●	●	●	●	●	●	●	●	●	●	●	●	●	●	●	●	●	●
<b>Thermal insulation value (in W/(m<sup>2</sup>·K))</b>																		
► Dependent on the size and frame type	For a product description, see from page 24																	
<b>Characteristics</b>																		
<b>EN 12207 – air permeability</b>	Class 4 (closed and locked) / class 3 (locked in latch)																	
<b>EN 12208 – water tightness under heavy rain</b>	Class 3a (locked in latch or closed and locked)																	
<b>EN 12219 – differential climate behaviour</b>	2d/2e																	
<b>Version in RC 2</b>																		
<b>Attack side = opening or closing side (hinge side or opposite hinge side)</b>																		
RC 2 with aluminium frame, hook bolt lock, or automatic lock (hook bolt lock), profile cylinder with drilling and pull-off protection as well as security card and guide rollers	○	○	○	○														
RC 2 with aluminium frame, hook bolt lock or automatic lock (hook bolt lock), profile cylinder with drilling and pull-off protection as well as security card, guide rollers and safety glass P4A									○		○	○	○				○	○
RC 2 with side element / transom light (P4A safety glass)	○	○	○	○					○		○	○	○				○	○
<b>Attack side = opening or closing side (hinge side or opposite hinge side)</b>																		
RC 2 with aluminium frame, multiple-point locking (entrance door automation), profile cylinder with drilling and pull-off protection as well as security card and guide rollers	○	○	○															
RC 2 with aluminium frame, multiple-point locking (entrance door automation), profile cylinder with drilling and pull-off protection as well as security card, guide rollers and safety glass P4A									○		○	○	○	○			○	○
RC 2 with side element / transom light (P4A safety glass)	○	○	○						○		○	○	○	○			○	○
<b>Size ranges</b>																		
Size ranges in which an RC 2 version is possible	○								○		○	○	○	○			○	○
		○	○															
<b>Fittings</b>																		
<b>Hinges</b>																		
3 two-part guide rollers (180 mm), 3-way adjustable, with cover caps (stainless steel look), with securing pin	●	●	●	●	●	●	●	●	●	●	●	●	●	●	●	●	●	●
<b>Door handle (exterior)</b>																		
Exterior handle HB 14-2, brushed stainless steel	●	●	●	●	●	●	○	○	○	○	○	○	○	○	○	○	○	○
Exterior handle HB 38-2, brushed stainless steel	○	○	○	○	○	○	●	●	●	●	●	●	●	●	●	●	●	●
<b>Door handle (interior)</b>																		
Stainless steel lever handle	●	●	●	●	●	●	●	●	●	●	●	●	●	●	●	●	●	●
<b>Rose escutcheon (exterior and interior)</b>																		
Oval stainless steel profile cylinder rose escutcheons	●	●	●	●	●	●	●	●	●	●	●	●	●	●	●	●	●	●
<b>Profile cylinder</b>																		
Cylinder length 40.5 × 40.5 mm, with 5 keys, with emergency and hazard function	●	●	●	●	●	●	●	●	●	●	●	●	●	●	●	●	●	●
<b>Glazing frame</b>																		
Stainless steel, bonded									●	●	●	●	●	●	●	●	●	●
Profile-style plastic, clipped					●	●												

# Thermo65 entrance doors

## Entrance door programme

### Product description

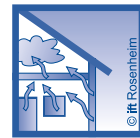

- Standard
- Optional

Product description	Thermo65 – steel THP																	
	010	015	515	100	410S	430E	600S	610S	700B/N	730B	750C	800S	810E/N	820S	830S	840S	850B	900D
<b>Glazing</b> (for details on glass design, see style descriptions on pages 36 – 40)																		
<b>B</b> Insulated triple glazing, sand-blasted float with 7 clear stripes									●	●								●
<b>C</b> Insulated triple glazing, sand-blasted float with 5 clear stripes											●							
<b>D</b> Insulated triple glazing, sand-blasted float with 4 clear stripes																		●
<b>E</b> Insulated triple glazing, sand-blasted float with clear stripes (frame)						●							●					
<b>S</b> Insulated triple glazing, Satinato					●		●	●				●		●	●	●		
<b>N</b> Insulated triple glazing, one-way plate glass									●				●					
<b>Side element / transom light</b>																		
For doors opening inwards	○	○	○	○	○	○	○	○	○	○	○	○	○	○	○	○	○	○
For doors opening outwards	○	○	○	○	○	○	○	○	○	○	○	○	○	○	○	○	○	○

Styles THP 010 and THP 700B with acoustic insulation

See page 28



## Notes and sketches

---

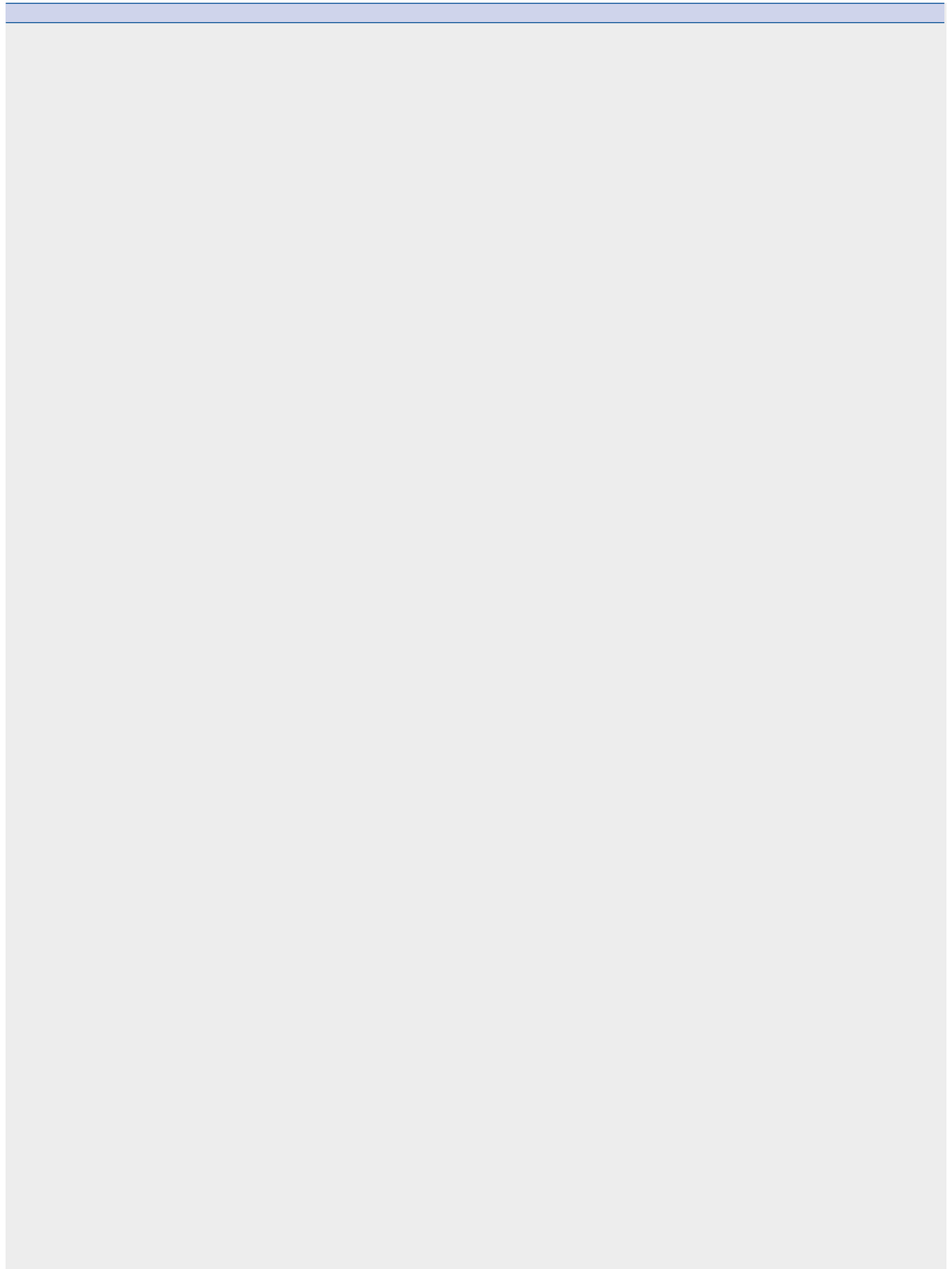

# Thermo65 entrance doors with acoustic insulation

## Entrance door programme



## Product description

● Standard      ○ Optional      X not possible

Product description	Thermo65 – steel THP	
	010	700 B
<b>Function</b>		
Acoustic insulation with threshold	<b>Class 3 (43 dB)</b>	<b>Class 3 (43 dB)</b>
Acoustic insulation with retractable bottom seal	<b>Class 2 (38 dB)</b>	<b>Class 2 (38 dB)</b>
<b>Door leaf structure</b>		
Smooth sheet	●	●
Door leaf thickness	65 mm thick	
Sheet thickness	1.5 mm	
Insert made of mineral wool and gypsum board, glued, with thermal break, Exterior and interior overlapping the leaf	●	●
<b>Size ranges (see also page 30)</b>		
Standard sizes (RAM)	1000 × 2100 mm, 1100 × 2100 mm and 1150 × 2200 mm	
Special sizes (RAM)	700 – 1250 mm Width 1875 – 2250 mm Height on request	on request
<b>Surface finish</b>		
<b>Note:</b> For doors with dark surfaces, the material expansion is particularly high. Therefore, please check the location of the door in the building during consultation. This will ensure trouble-free door operation.		
<b>Standard</b> Painted in Traffic white based on RAL 9016 on both sides, silk matt, gloss level 35 – 40 %	●	●
<b>Preferred colour</b> 22 preferred colours, painted on both sides, based on the RAL colour chart, silk matt, gloss level 35 – 40 %	●	●
<b>Matt deluxe</b> 6 colours, painted on both sides, matt, gloss level 3 – 8 %	●	●
<b>Decor</b> Film coating, on both sides	X	X
<b>Seals</b>		
Door leaf: 4-sided, double seals Frame: 3-sided seals	●	●
<b>Lock</b>		
Multiple-point locking with main lock (with soft lock latch) and 2 bolts, swing/hook bolt combination, main lock plate with adjustable latch slot, secondary lock plates with eccentric adjustment	●	●
<b>Electric strikes</b>		
Electric strike with day catch (separate)	○	○
<b>Security bolts</b>		
Safety strip on the hinge side	●	●
<b>Frames</b>		
Aluminium block frame with thermal break profile A3 or A4 (colour matching the door leaf) with aluminium / plastic threshold with thermal break (subsequent replacement possible)	●	●
<b>Threshold / door bottom edge</b>		
Threshold S11 / S12	●/○	●/○
Retractable bottom seal	○	○
<b>Thermal insulation value (in W/(m<sup>2</sup>·K))</b>		
► U <sub>D</sub> -value	0.95 W/(m <sup>2</sup> ·K)	1.1 W/(m <sup>2</sup> ·K)
<b>Characteristics</b>		
<b>EN 12207 – air permeability</b>	Class 4 (closed and locked) / class 3 (locked in latch)	
<b>EN 12208 – Water tightness under heavy rain</b>	Class 3a (locked in latch or closed and locked)	
<b>EN 12219 – differential climate behaviour</b>	2d / 2e	
<b>Version in RC 2</b>		
RC 2	X	X

# Thermo65 entrance doors with acoustic insulation

## Entrance door programme



## Product description

● Standard      ○ Optional      X not possible

Product description	Thermo65 – steel THP	
	010	700 B
<b>Fittings</b>		
<b>Hinges</b>		
3 two-part guide rollers (180 mm), 3-way adjustable, with cover caps (stainless steel look), with securing pin	●	●
<b>Door handle (exterior)</b>		
Handle HB 14-2 / HB 38-2 / HB 38-3 Brushed stainless steel	●/○/○	○/●/○
Handle HB 738 Brushed stainless steel	X	X
Offset push bar	X	X
Fitting ES 0	○	○
Fitting ES 1	○	○
Rose escutcheon	○	○
<b>Door handle (interior)</b>		
Stainless steel lever handle	●	●
<b>Rose escutcheon (exterior and interior)</b>		
Oval stainless steel profile cylinder rose escutcheons	●	●
<b>Profile cylinder</b>		
Cylinder length 40.5 × 40.5 mm, with 5 keys, with emergency and hazard function	●	●
<b>Glazing frame</b>		
Stainless steel, bonded		●
<b>Glazing</b> (for details on glass design, see style descriptions on pages 36 – 40)		
<b>B</b> Insulated triple glazing, sand-blasted float with 7 clear stripes		●
<b>Opening sense</b>		
Door set opening inwards	●	●
Door set opening outwards	○	○
<b>Optional extras</b>		
<ul style="list-style-type: none"> <li>• Door closer and reinforcement for door closers</li> <li>• Bottom spacer profile</li> <li>• Base profile</li> <li>• Bottom edge profile</li> <li>• Sealing strip</li> <li>• Bottom sheet</li> <li>• Stainless steel embellishments</li> <li>• Rain canopy</li> </ul>	<ul style="list-style-type: none"> <li>• Door drip</li> <li>• Electric strikes</li> <li>• Latch switching contact</li> <li>• Reed contact</li> </ul>	<ul style="list-style-type: none"> <li>•</li> <li>○</li> </ul>
<ul style="list-style-type: none"> <li>• Version in RC 2</li> <li>• Side element / transom light</li> <li>• Extension profile 25 mm / 50 mm</li> <li>• Cover profile</li> </ul>	<ul style="list-style-type: none"> <li>• Supplementary profile</li> </ul>	<ul style="list-style-type: none"> <li>X</li> </ul>

# Thermo65 entrance doors

## Entrance door programme

### Technical presentation of door set



#### THP entrance doors with aluminium frame, profile A3

Standard sizes		
Overall frame dimension Ordering size	Clear frame dimension	Structural opening
<b>1000 x 2100</b>	850 x 2005	1020 x 2110
<b>1100 x 2100</b>	950 x 2005	1120 x 2110
<b>1150 x 2200</b>	1000 x 2105	1170 x 2210

Special sizes		
THP Styles	Overall frame dimension	
	Width	Height
010/600/700/730/ 750/800/810/840	700 – 1250	1875 – 2250
820/830/850/900	800 – 1250	1875 – 2250
015/515/610	875 – 1250	1875 – 2250
100/410/430	875 – 1100	1875 – 2186

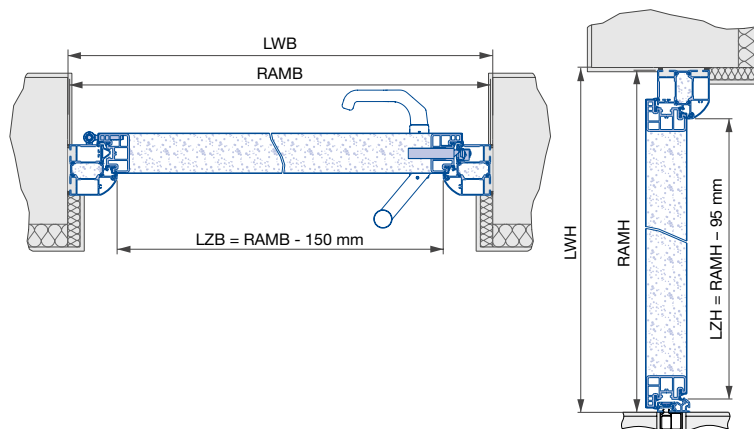

**RAMB** Overall frame width  
**RAMH** Overall frame height

**LWB** Structural opening width  
**LWH** Structural opening height  
**LZB** Clear frame dimension width  
**LZH** Clear frame dimension height

#### Wall connections for frames

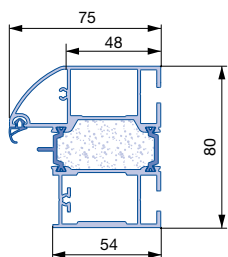

**Profile A3**

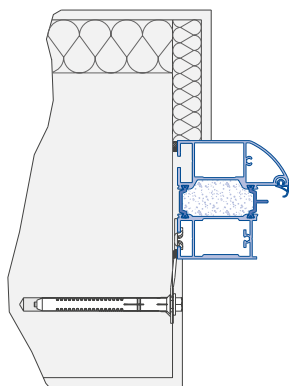

**Aluminium frame**  
with screw-in anchor  
(plug-and-screw fitting)

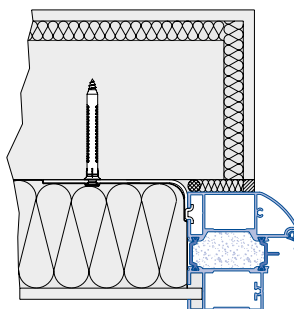

**Aluminium frame**  
to the wall  
with screw-in anchor (plug-and-screw fitting)

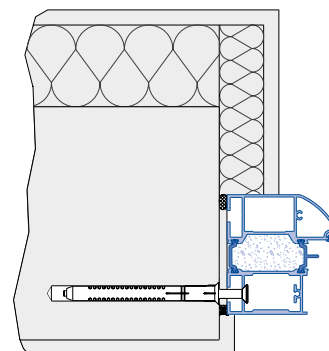

**Aluminium frame**  
Through-bolt fixing  
(Drill holes on site or optionally at a surcharge)

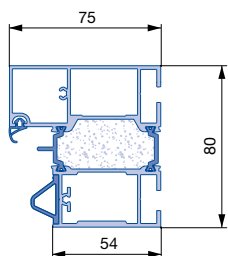

**Profile A4**

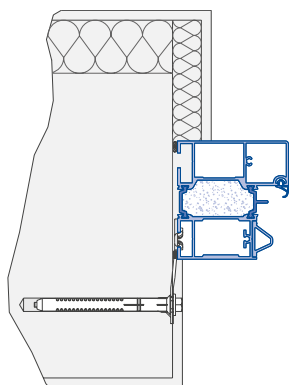

**Aluminium frame**  
with screw-in anchor  
(plug-and-screw fitting)

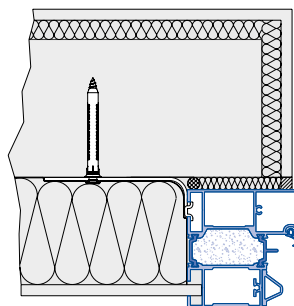

**Aluminium frame**  
to the wall  
with screw-in anchor (plug-and-screw fitting)

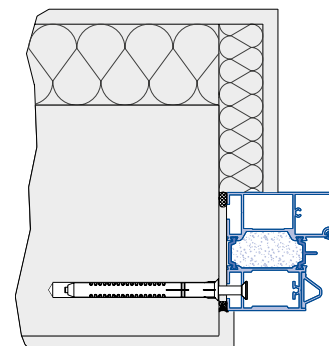

**Aluminium frame**  
Through-bolt fixing  
(Drill holes on site or optionally at a surcharge)

# Thermo65 entrance doors

Entrance door programme

Technical presentation of door set



## Wall connections for frames

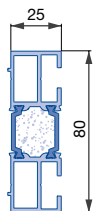

**Extension profile 25 mm**  
(optional)

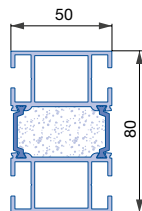

**Extension profile 50 mm**  
(optional)

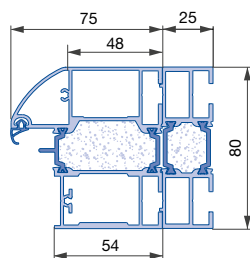

**With aluminium frame profile A3**  
(Shown with extension profile 25 mm)

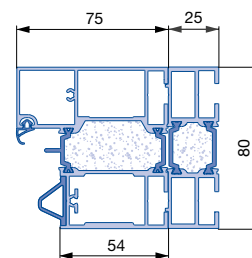

**With aluminium frame profile A4**  
(Shown with extension profile 25 mm)

## Bottom edge

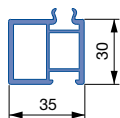

**Bottom spacer profile**  
(optional)

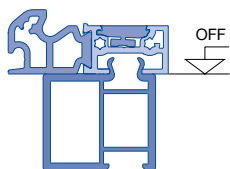

**With 1 bottom spacer profile**

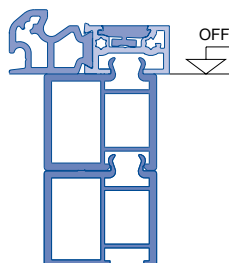

**With 2 bottom spacer profiles**

**FFL** Finished floor level

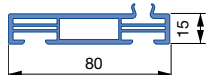

**Base profile**  
(optional)

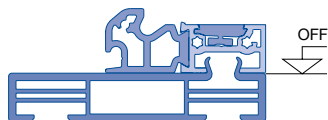

**Base profile below FFL**

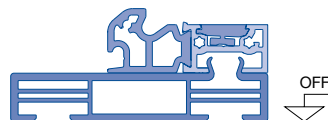

**Base profile above FFL**

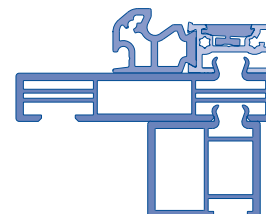

**Base profile and bottom spacer profile**  
Can be combined

## Retractable bottom seal (optional)

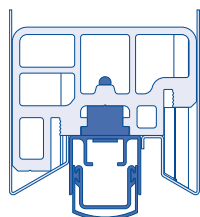

## Threshold rails

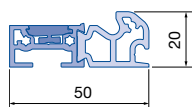

**Threshold S11**  
(Standard)

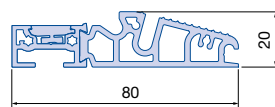
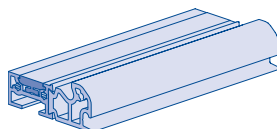

**Threshold S12**  
(Optional)

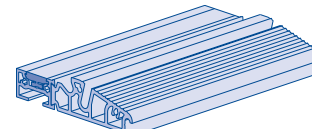

# Thermo65 entrance doors

## Entrance door programme

### Technical presentation of door set with side element / transom light



#### THP entrance doors with side element / transom light

Standard sizes – side element		
THP Styles	Overall frame dimension	
	Width	Height
All styles	400	2100
	400	2200

Special sizes – side element		
THP Styles	Overall frame dimension	
	Width	Height
All styles	See pages 56 and 57	

Size range – transom light		
THP Styles	Overall frame dimension	
	Width	Height
All styles	See page 56	

Clear view		
	Width	Height
Side element	RAM side element – 134	RAM side element – 134
Transom light	RAM transom light – 134	RAM transom light – 134

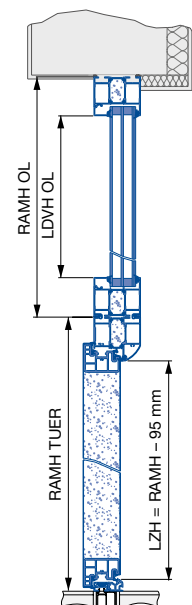
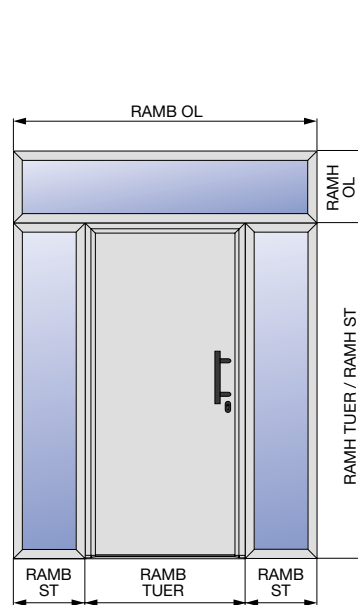
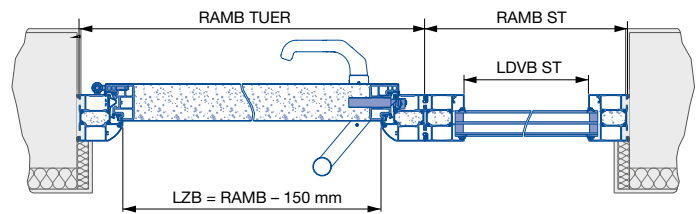
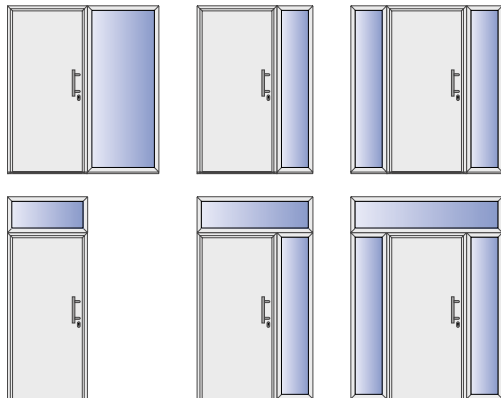

**RAMB** Overall frame width  
**RAMH** Overall frame height  
**TUER** Door  
**ST** Side element  
**OL** Transom light

**LWB** Structural opening width  
**LWH** Structural opening height  
**LZB** Clear frame dimension width  
**LZH** Clear frame dimension height  
**LDVB** Glazing clear view width  
**LDVH** Glazing clear view height

## Notes and sketches

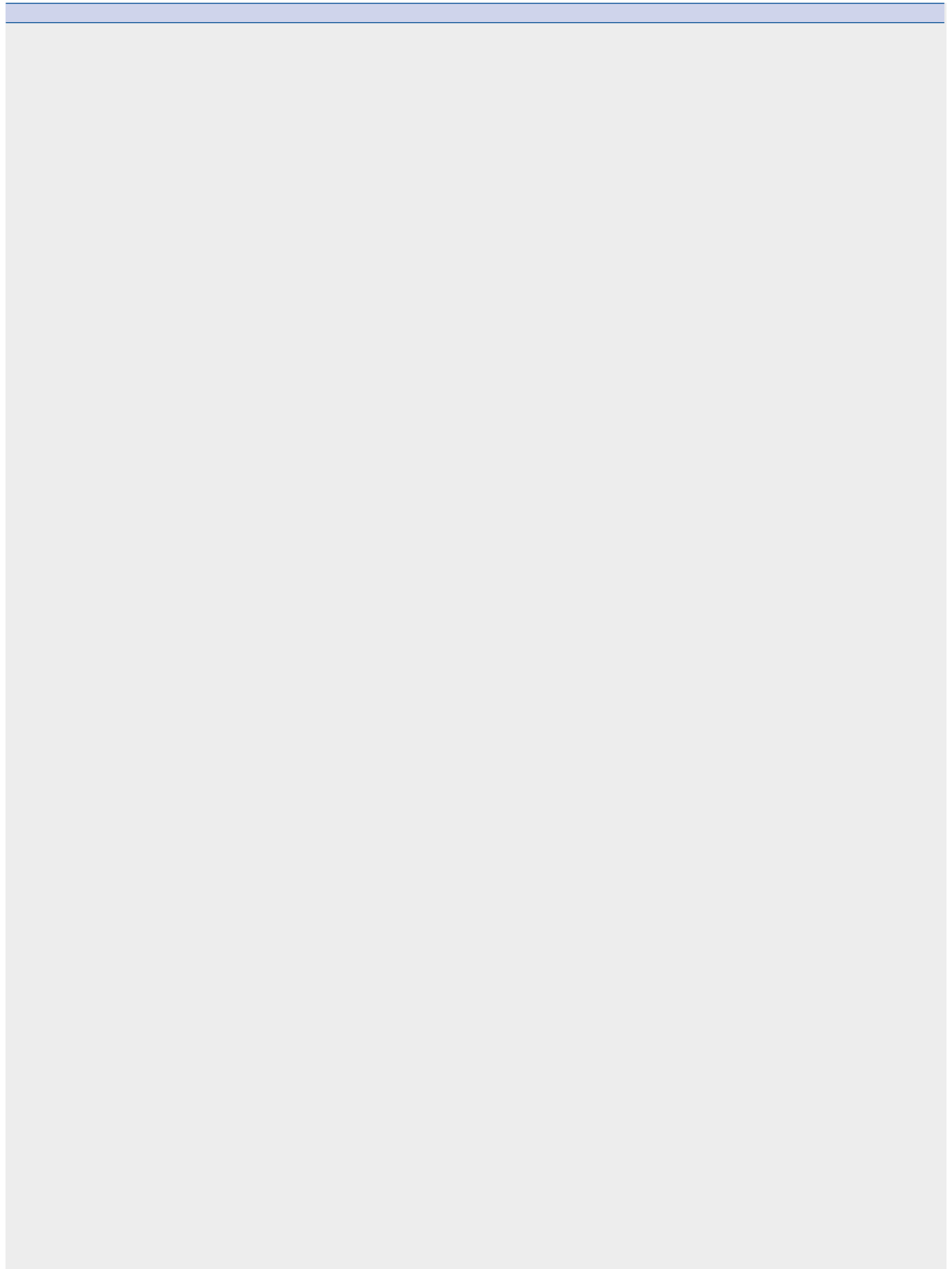



# Thermo65 entrance doors

Entrance door programme

Technical presentation of clear view for doors with glazing / ribbing



## Clear view for styles with glazing

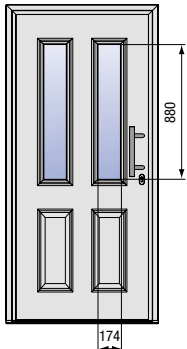

THP 410S

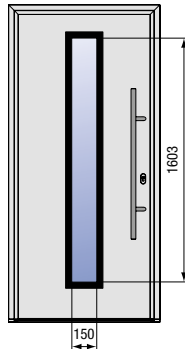

THP 600S

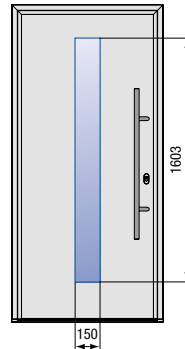

THP 610S/N

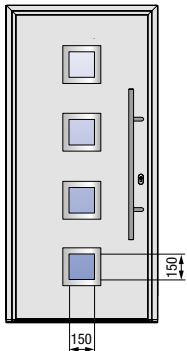

THP 800S

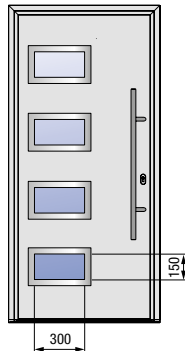

THP 820S

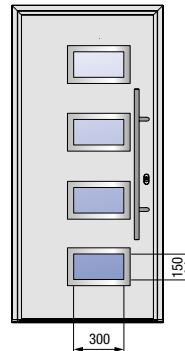

THP 830S

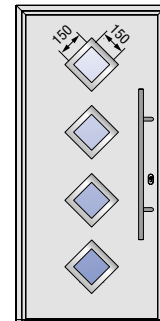

THP 840S

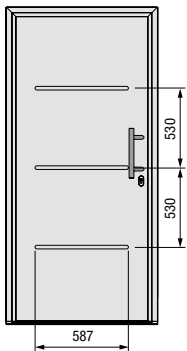

THP 515

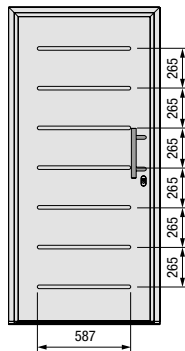

THP 015

# Thermo65 entrance doors

## Entrance door programme

### Technical presentation of clear view for doors with glazing



#### Clear view for styles with glazing

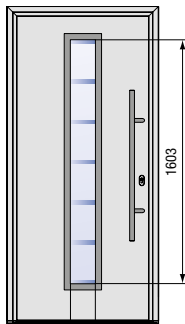

#### THP 700B/N

Float glass sand-blasted with 7 clear horizontal stripes; stripes 35 mm high at the top, 20 mm in the centre, 35 mm at the bottom

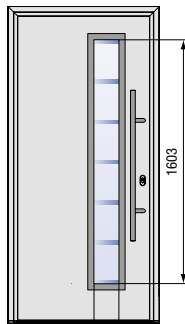

#### THP 730B

Float glass sand-blasted with 7 clear horizontal stripes; stripes 35 mm high at the top, 20 mm in the centre, 35 mm at the bottom

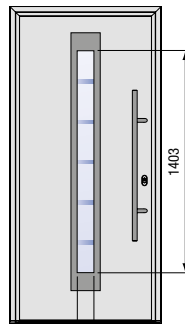

#### THP 750C

Float glass sand-blasted with 5 clear horizontal stripes, each 20 mm high

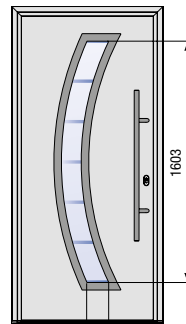

#### THP 850B

Float glass sand-blasted with 7 clear horizontal stripes; stripes 35 mm high at the top, 20 mm in the centre, 35 mm at the bottom

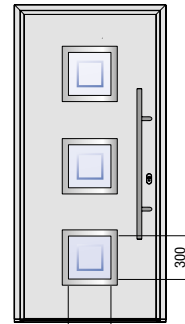

#### THP 810E/N

Float glass sand-blasted with square with clear edge 20 mm

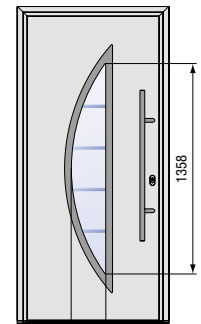

#### THP 900D

Float glass sand-blasted with 4 clear horizontal stripes, each 20 mm high

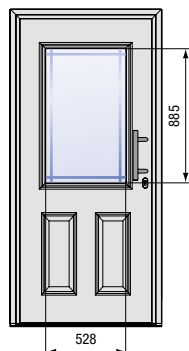
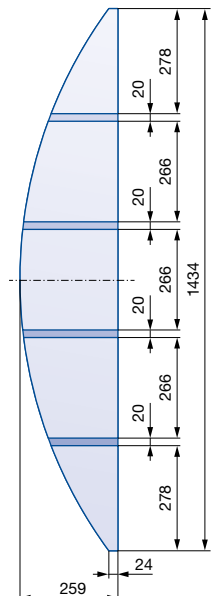
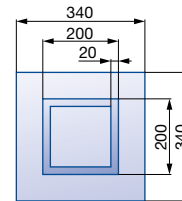
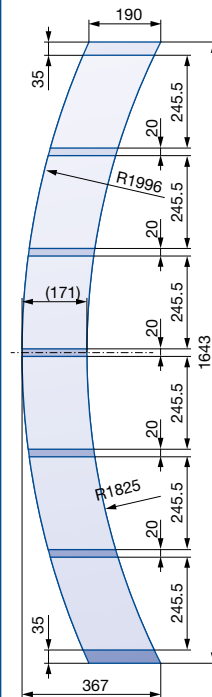
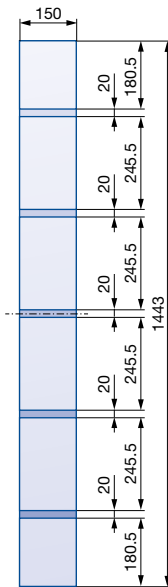
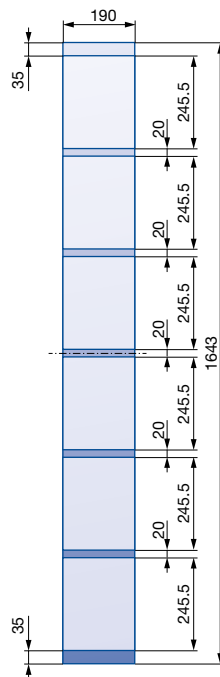

#### THP 430E

# Thermo65 entrance doors

## Entrance door programme



For a product description, see from page 24

- Steel door leaf with thermal break overlapping the leaf, exterior and interior in the same colour
- Aluminium frame
- Multiple-point locking

**Preferred colour** 22 preferred colours (see page 24)

**Matt deluxe** 6 colours (see page 24)

**Decor** Golden Oak, Dark Oak, Night Oak, Winchester Oak and Titan Metallic CH 703

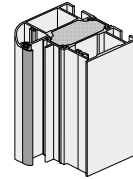

Profile A3

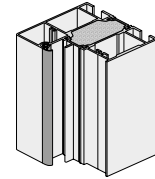

A4 profile

or

View	Style description	Size (RAM)	RAL 9016	Preferred colour	Matt deluxe	Decor
	<b>Style THP 010</b> <ul style="list-style-type: none"> <li>• Smooth sheet</li> <li>• Handle HB 14-2</li> </ul>	1000 × 2100	<b>1639</b>	<b>1764</b>	<b>1859</b>	<b>1888</b>
		1100 × 2100				
		1150 × 2200				
		From 700 × 1875 Up to 1250 × 2250	<b>2024</b>	<b>2149</b>	<b>2244</b>	<b>2273</b>
▶ U <sub>D</sub> -value for dimensions 1230 × 2180 mm: 0.87 W/(m <sup>2</sup> ·K)						
	<b>Style THP 015</b> <ul style="list-style-type: none"> <li>• Ribbed sheet with 7 ribs (exterior)</li> <li>• Handle HB 14-2</li> </ul>	1000 × 2100	<b>1727</b>	<b>1852</b>	<b>1947</b>	<b>1976</b>
		1100 × 2100				
		1150 × 2200				
		From 875 × 1875 Up to 1250 × 2250	<b>2112</b>	<b>2237</b>	<b>2332</b>	<b>2361</b>
▶ U <sub>D</sub> -value for dimensions 1230 × 2180 mm: 0.87 W/(m <sup>2</sup> ·K)						
	<b>Style THP 515</b> <ul style="list-style-type: none"> <li>• Ribbed sheet with 3 ribs (exterior)</li> <li>• Handle HB 14-2</li> </ul>	1000 × 2100	<b>1727</b>	<b>1852</b>	<b>1947</b>	<b>1976</b>
		1100 × 2100				
		1150 × 2200				
		From 875 × 1875 Up to 1250 × 2250	<b>2112</b>	<b>2237</b>	<b>2332</b>	<b>2361</b>
▶ U <sub>D</sub> -value for dimensions 1230 × 2180 mm: 0.87 W/(m <sup>2</sup> ·K)						

# Thermo65 entrance doors

## Entrance door programme



For a product description, see from page 24

- Steel door leaf with thermal break overlapping the leaf, exterior and interior in the same colour
- Aluminium frame
- Multiple-point locking

**Preferred colour** 22 preferred colours (see page 24)

**Matt deluxe** 6 colours (see page 24)

**Decor** Golden Oak, Dark Oak, Night Oak, Winchester Oak and Titan Metallic CH 703

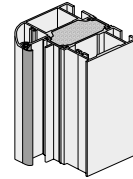

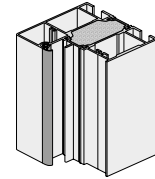

Profile A3



A4 profile

or

View	Style description	Size (RAM)	RAL 9016	Preferred colour	Matt deluxe	Decor
	<b>Style THP 100</b> <ul style="list-style-type: none"> <li>• Panelled sheet (on both sides)</li> <li>• Handle HB 14-2</li> </ul>	1000 × 2100	<b>1671</b>	<b>1796</b>	<b>1891</b>	-
		1100 × 2100				
		From 875 × 1875 Up to 1100 × 2186	<b>2056</b>	<b>2181</b>	<b>2276</b>	-
▶ U <sub>D</sub> -value for dimensions 1230 × 2180 mm: 0.87 W/(m <sup>2</sup> ·K)						
	<b>Style THP 410S</b> <ul style="list-style-type: none"> <li>• Panelled sheet (on both sides)</li> <li>• 3 panes of insulated glass, exterior laminated safety glass – Satinato – interior laminated safety glass</li> <li>• Plastic glazing frame</li> <li>• Handle HB 14-2</li> </ul>	1000 × 2100	<b>2754</b>	<b>3165</b>	<b>3262</b>	-
		1100 × 2100				
		From 875 × 1875 Up to 1100 × 2186	<b>3140</b>	<b>3551</b>	<b>3648</b>	-
▶ U <sub>D</sub> -value for dimensions 1230 × 2180 mm: 1.0 W/(m <sup>2</sup> ·K)						
	<b>Style THP 430E</b> <ul style="list-style-type: none"> <li>• Panelled sheet (on both sides)</li> <li>• 3 panes of insulated glass, exterior laminated safety glass – sand-blasted float with clear stripes (frame) – interior laminated safety glass</li> <li>• Plastic glazing frame</li> <li>• Handle HB 14-2</li> </ul>	1000 × 2100	<b>2754</b>	<b>3165</b>	<b>3262</b>	-
		1100 × 2100				
		From 875 × 1875 Up to 1100 × 2186	<b>3140</b>	<b>3551</b>	<b>3648</b>	-
▶ U <sub>D</sub> -value for dimensions 1230 × 2180 mm: 1.0 W/(m <sup>2</sup> ·K)						

# Thermo65 entrance doors

## Entrance door programme



For a product description, see from page 24

- Steel door leaf with thermal break overlapping the leaf, exterior and interior in the same colour
- Aluminium frame
- Multiple-point locking

**Preferred colour** 22 preferred colours (see page 24)

**Matt deluxe** 6 colours (see page 24)

**Decor** Golden Oak, Dark Oak, Night Oak, Winchester Oak and Titan Metallic CH 703

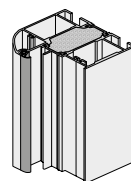

Profile A3

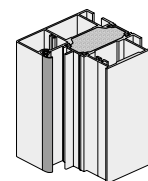

A4 profile

View	Style description	Size (RAM)	RAL 9016	Preferred colour	Matt deluxe	Decor
	<b>Style THP 600S</b> <ul style="list-style-type: none"> <li>• Smooth sheet</li> <li>• Insulated glass, exterior single-pane safety glass Satinato, edge with silkscreen – clear float / single-pane safety glass – interior single-pane safety glass Satinato, edge with silkscreen, surface-mounted exterior pane</li> <li>• Handle HB 38-2</li> </ul>	1000 × 2100	<b>2892</b>	<b>3017</b>	<b>3112</b>	<b>3141</b>
		1100 × 2100				
1150 × 2200						
	<b>Style THP 610S</b> // NEW <ul style="list-style-type: none"> <li>• Smooth sheet</li> <li>• 3 panes of insulated glass, exterior laminated safety glass – Satinato – interior laminated safety glass</li> <li>• Handle HB 38-2</li> </ul>	From 1000 × 2100	<b>2572</b>	<b>2697</b>	<b>2792</b>	-
		Up to 1100 × 2100				
to 1150 × 2200						
	<b>Style THP 610N</b> // NEW <ul style="list-style-type: none"> <li>• Smooth sheet</li> <li>• 3 panes of insulated glass, exterior laminated safety glass – one-way plate glass – interior single-pane safety glass</li> <li>• Handle HB 38-2</li> </ul>	From 1000 × 2100	<b>2736</b>	<b>2861</b>	<b>2956</b>	-
		Up to 1100 × 2100				
to 1150 × 2200						
	<b>Style THP 700B</b> <ul style="list-style-type: none"> <li>• Smooth sheet</li> <li>• 3 panes of insulated glass, exterior laminated safety glass – sand-blasted float with 7 clear stripes – interior single-pane safety glass</li> <li>• Stainless steel glazing frame</li> <li>• Handle HB 38-2</li> </ul>	From 1000 × 2100	<b>2572</b>	<b>2697</b>	<b>2792</b>	<b>2821</b>
		Up to 1100 × 2100				
to 1150 × 2200						
	<b>Style THP 700N</b> // NEW <ul style="list-style-type: none"> <li>• Smooth sheet</li> <li>• 3 panes of insulated glass, exterior laminated safety glass – one-way plate glass – interior single-pane safety glass</li> <li>• Stainless steel glazing frame</li> <li>• Handle HB 38-2</li> </ul>	From 1000 × 2100	<b>2736</b>	<b>2861</b>	<b>2956</b>	<b>2985</b>
		Up to 1100 × 2100				
to 1150 × 2200						

► U<sub>D</sub>-value for dimensions 1230 × 2180 mm: 1.00 W/(m<sup>2</sup>·K)

From 875 × 2000

to 1250 × 2250

From 875 × 2000

Up to 1250 × 2250

From 700 × 1875

Up to 1250 × 2250

► U<sub>D</sub>-value for dimensions 1230 × 2180 mm: 0.98 W/(m<sup>2</sup>·K)

From 700 × 1875

Up to 1250 × 2250

# Thermo65 entrance doors

## Entrance door programme



For a product description, see from page 24

- Steel door leaf with thermal break overlapping the leaf, exterior and interior in the same colour
- Aluminium frame
- Multiple-point locking

**Preferred colour** 22 preferred colours (see page 24)

**Matt deluxe** 6 colours (see page 24)

**Decor** Golden Oak, Dark Oak, Night Oak, Winchester Oak and Titan Metallic CH 703

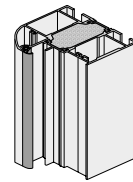



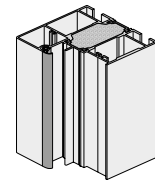

Profile A3



or

A4 profile

View	Style description	Size (RAM)	RAL 9016	Preferred colour	Matt deluxe	Decor
	<b>Style THP 730B</b> // NEW					
	• Smooth sheet	1000 × 2100				
	• 3 panes of insulated glass, exterior laminated safety glass – sand-blasted float with 7 clear stripes – interior single-pane safety glass	1100 × 2100 1150 × 2200	<b>2572</b>	<b>2697</b>	<b>2792</b>	<b>2821</b>
	• Stainless steel glazing frame	From 700 × 1875				
	• Handle HB 38-2	Up to 1250 × 2250	<b>2957</b>	<b>3082</b>	<b>3177</b>	<b>3206</b>
▶ U <sub>D</sub> -value for dimensions 1230 × 2180 mm: 0.98 W/(m <sup>2</sup> ·K)						
	<b>Style THP 750C</b>					
	• Smooth sheet	1000 × 2100				
	• 3 panes of insulated glass, exterior laminated safety glass – sand-blasted float with 5 clear stripes – interior single-pane safety glass	1100 × 2100 1150 × 2200	<b>2572</b>	<b>2697</b>	<b>2792</b>	<b>2821</b>
	• Stainless steel glazing frame	From 700 × 1875				
	• Handle HB 38-2	Up to 1250 × 2250	<b>2957</b>	<b>3082</b>	<b>3177</b>	<b>3206</b>
▶ U <sub>D</sub> -value for dimensions 1230 × 2180 mm: 0.95 W/(m <sup>2</sup> ·K)						
	<b>Style THP 800S</b>					
	• Smooth sheet	1000 × 2100				
	• 3 panes of insulated glass, exterior laminated safety glass – Satinato – interior laminated safety glass	1100 × 2100 1150 × 2200	<b>2760</b>	<b>2885</b>	<b>2980</b>	<b>3009</b>
	• Stainless steel glazing frame	From 700 × 1875				
	• Handle HB 38-2	Up to 1250 × 2250	<b>3146</b>	<b>3271</b>	<b>3366</b>	<b>3395</b>
▶ U <sub>D</sub> -value for dimensions 1230 × 2180 mm: 0.93 W/(m <sup>2</sup> ·K)						
	<b>Style THP 810E</b>					
	• Smooth sheet	1000 × 2100				
	• 3 panes of insulated glass, exterior laminated safety glass – sand-blasted float with clear stripes (square) – interior single-pane safety glass	1100 × 2100 1150 × 2200	<b>2760</b>	<b>2885</b>	<b>2980</b>	<b>3009</b>
	• Stainless steel glazing frame	From 700 × 1875				
	• Handle HB 38-2	Up to 1250 × 2250	<b>3146</b>	<b>3271</b>	<b>3366</b>	<b>3395</b>
▶ U <sub>D</sub> -value for dimensions 1230 × 2180 mm: 0.97 W/(m <sup>2</sup> ·K)						
	<b>Style THP 810N</b> // NEW					
	• Smooth sheet	1000 × 2100				
	• 3 panes of insulated glass, exterior laminated safety glass – one-way plate glass – interior single-pane safety glass	1100 × 2100 1150 × 2200	<b>2925</b>	<b>3050</b>	<b>3145</b>	<b>3174</b>
	• Stainless steel glazing frame	From 700 × 1875				
	• Handle HB 38-2	Up to 1250 × 2250	<b>3311</b>	<b>3435</b>	<b>3531</b>	<b>3560</b>

# Thermo65 entrance doors

## Entrance door programme



For a product description, see from page 24

- Steel door leaf with thermal break overlapping the leaf, exterior and interior in the same colour
- Aluminium frame
- Multiple-point locking

**Preferred colour** 22 preferred colours (see page 24)

**Matt deluxe** 6 colours (see page 24)

**Decor** Golden Oak, Dark Oak, Night Oak, Winchester Oak and Titan Metallic CH 703

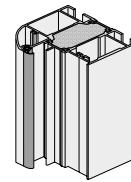

Profile A3

or

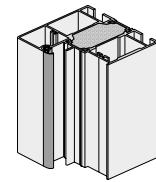

A4 profile

View	Style description	Size (RAM)	RAL 9016	Preferred colour	Matt deluxe	Decor
	<b>Style THP 820S</b> <ul style="list-style-type: none"> <li>• Smooth sheet</li> <li>• 3 panes of insulated glass, exterior laminated safety glass – Satinato – interior laminated safety glass</li> <li>• Stainless steel glazing frame</li> <li>• Handle HB 38-2</li> </ul>	1000 × 2100	2760	2885	2980	3009
		1100 × 2100				
		1150 × 2200				
From	800 × 1875	3146	3271	3366	3395	
Up to	1250 × 2250					
▶ U <sub>D</sub> -value for dimensions 1230 × 2180 mm: 0.95 W/(m <sup>2</sup> ·K)						
	<b>Style THP 830S</b> // NEW <ul style="list-style-type: none"> <li>• Smooth sheet</li> <li>• 3 panes of insulated glass, exterior laminated safety glass – Satinato – interior laminated safety glass</li> <li>• Stainless steel glazing frame</li> <li>• Handle HB 38-2</li> </ul>	1000 × 2100	2760	2885	2980	3009
		1100 × 2100				
		1150 × 2200				
From	800 × 1875	3146	3271	3366	3395	
Up to	1250 × 2250					
▶ U <sub>D</sub> -value for dimensions 1230 × 2180 mm: 0.95 W/(m <sup>2</sup> ·K)						
	<b>Style THP 840S</b> // NEW <ul style="list-style-type: none"> <li>• Smooth sheet</li> <li>• 3 panes of insulated glass, exterior laminated safety glass – Satinato – interior laminated safety glass</li> <li>• Stainless steel glazing frame</li> <li>• Handle HB 38-2</li> </ul>	1000 × 2100	2760	2885	2980	3009
		1100 × 2100				
		1150 × 2200				
From	800 × 1875	3146	3271	3366	3395	
Up to	1250 × 2250					
▶ U <sub>D</sub> -value for dimensions 1230 × 2180 mm: 0.95 W/(m <sup>2</sup> ·K)						
	<b>Style THP 850B</b> <ul style="list-style-type: none"> <li>• Smooth sheet</li> <li>• 3 panes of insulated glass, exterior laminated safety glass – sand-blasted float with 7 clear stripes – interior laminated safety glass</li> <li>• Stainless steel glazing frame</li> <li>• Handle HB 38-2</li> </ul>	1000 × 2100	2985	3110	3205	3234
		1100 × 2100				
		1150 × 2200				
From	800 × 1875	3370	3495	3590	3619	
Up to	1250 × 2250					
▶ U <sub>D</sub> -value for dimensions 1230 × 2180 mm: 0.97 W/(m <sup>2</sup> ·K)						
	<b>Style THP 900D</b> <ul style="list-style-type: none"> <li>• Smooth sheet</li> <li>• 3 panes of insulated glass, exterior laminated safety glass – sand-blasted float with 4 clear stripes – interior single-pane safety glass</li> <li>• Stainless steel glazing frame</li> <li>• Handle HB 38-2</li> </ul>	1000 × 2100	2760	2885	2980	3009
		1100 × 2100				
		1150 × 2200				
From	800 × 1875	3146	3271	3366	3395	
Up to	1250 × 2250					
▶ U <sub>D</sub> -value for dimensions 1230 × 2180 mm: 0.96 W/(m <sup>2</sup> ·K)						

Accessories and optional extras

See from page 41





# Thermo65 entrance doors

## Entrance door programme

### Accessories

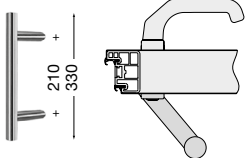
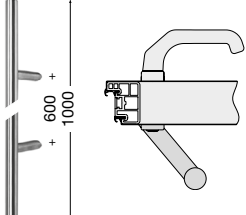
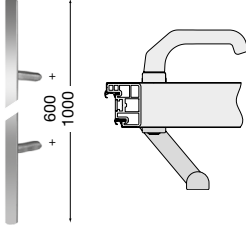
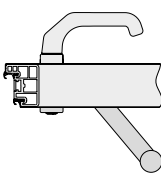
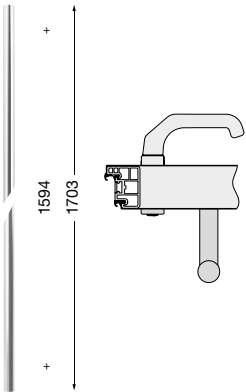

Thermo65 entrance doors with acoustic insulation (For a product description, see page 28)		£												
 	<p><b>Acoustic insulation class 3 (43 dB) with threshold</b></p> <hr/> <p><b>Acoustic insulation class 2 (38 dB) with retractable bottom seal</b></p>	<p>Per door <b>529</b></p> <hr/> <p>Per door <b>833</b></p>												
<b>Exterior door handles (included in door price)</b> <span style="float: right;">£</span>														
	<p><b>Handle HB 14-2</b></p> <ul style="list-style-type: none"> <li>Brushed stainless steel</li> <li>As standard for styles THP 010, THP 015, THP 100, THP 410, THP 430 and THP 515</li> </ul>	<p>Surcharge for conversion to handle HB 14-2 <b>137</b></p>												
	<p><b>Handle HB 38-2</b></p> <ul style="list-style-type: none"> <li>Brushed stainless steel</li> <li>As standard for styles THP 600, THP 700, THP 750, THP 800, THP 810, THP 820, THP 850 and THP 900</li> </ul>	<p>Surcharge for conversion to handle HB 38-2 <b>137</b></p>												
	<p><b>Handle HB 38-3</b></p> <ul style="list-style-type: none"> <li>Brushed stainless steel</li> </ul>	<p>Surcharge for conversion to handle HB 38-3 <b>137</b></p>												
	<p><b>Handle offset 40 mm</b></p> <ul style="list-style-type: none"> <li>Push bar offset by approx. 40 mm</li> <li>Possible with handles HB 14-2, HB 38-2, HB 38-3</li> </ul>	<p>Surcharge for offset by 40 mm for handles HB 14-2, HB 38-2 and HB 38-3 <b>137</b></p> <table border="1"> <thead> <tr> <th>Style</th> <th>From RAM width</th> </tr> </thead> <tbody> <tr> <td>THP 010, THP 600, THP 700, THP 750, THP 800</td> <td>700 mm</td> </tr> <tr> <td>THP 015, THP 515, THP 100</td> <td>938 mm</td> </tr> <tr> <td>THP 410, THP 430</td> <td>954 mm</td> </tr> <tr> <td>THP 810</td> <td>704 mm</td> </tr> <tr> <td>THP 820, THP 850, THP 900</td> <td>800 mm</td> </tr> </tbody> </table>	Style	From RAM width	THP 010, THP 600, THP 700, THP 750, THP 800	700 mm	THP 015, THP 515, THP 100	938 mm	THP 410, THP 430	954 mm	THP 810	704 mm	THP 820, THP 850, THP 900	800 mm
Style	From RAM width													
THP 010, THP 600, THP 700, THP 750, THP 800	700 mm													
THP 015, THP 515, THP 100	938 mm													
THP 410, THP 430	954 mm													
THP 810	704 mm													
THP 820, THP 850, THP 900	800 mm													
	<p><b>Handle HB 738</b></p> <ul style="list-style-type: none"> <li>Brushed stainless steel</li> <li>Handle HB 738 only possible for styles THP 010, THP 600, THP 700, THP 750 and THP 800.</li> </ul>	<p>Surcharge for conversion to handle HB 738 <b>349</b></p>												

# Thermo65 entrance doors

## Entrance door programme

### Accessories

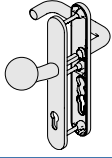
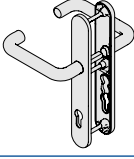
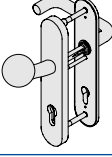
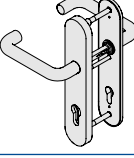
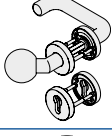
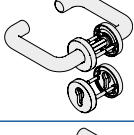
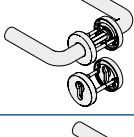
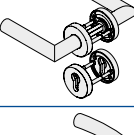
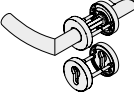

ES 0 fittings	Including profile cylinder with 5 keys		Surcharges	£
	Knob / lever handle	Stainless steel	Each	137
	Lever handle / lever handle	Stainless steel	Each	137
ES 1 fittings	Including profile cylinder with 5 keys		Surcharges	£
<b>Note:</b> ES 1 fittings are only possible from a RAM width of 900 mm for styles THP 410 and THP 430.				
	Knob / lever handle	Stainless steel	Each	220
	Lever handle / lever handle	Stainless steel	Each	220
Rose escutcheons	Including profile cylinder with 5 keys		Surcharges	£
<b>Note:</b> The rose escutcheons are only possible from a RAM width of 900 mm for styles THP 410 and THP 430.				
	Knob K-160 / lever handle, type D-110	Stainless steel	Each	137
	Lever handle / lever handle, type D-110	Stainless steel	Each	137
	Lever handle / lever handle, type D-210	Stainless steel	Each	137
	Lever handle / lever handle, type D-310	Stainless steel	Each	137
	Lever handle / lever handle, type D-510	Stainless steel	Each	137

# Thermo65 entrance doors

## Entrance door programme

### Accessories



#### Calculation example £

**Conversion  
THP 010 with HB 14-2  
to  
HB 38-2**

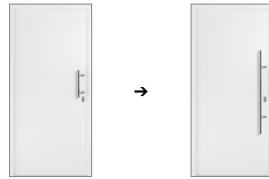

Style THP 010 in RAL 9016, profile A3 (standard size)	<b>1639</b>
+ Conversion from handle HB 14-2 to handle HB 38-2	<b>137</b>
<b>= Total</b>	<b>1776</b>

**Conversion  
THP 700 with HB 38-2  
to  
Fitting ES 1**

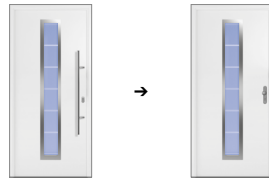

Style THP 700 in RAL 9016, profile A3 (standard size)	<b>2572</b>
+ Surcharge for ES 1 stainless steel knob/lever handle fitting	<b>220</b>
<b>= Total</b>	<b>2792</b>

#### Accessory package "black.edition" Surcharges £

**On version with the respective fitting (note the change in handle)**



- Exterior push bar HN 38-2 in black
- Interior lever in black
- Oval rose escutcheons for profile cylinder, black
- Black cover caps

Per door **110**

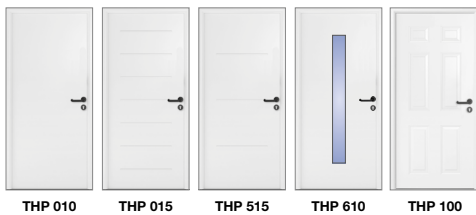

- Lever handle set lever handle/lever handle D-110, black
- Round rose escutcheons for profile cylinders, black
- Black cover caps

Per door **55**

- Suitable for styles:
- THP 010, 015, 515 and 100
  - THP 610



THP 700

- Exterior push bar HN 38-2 in black
- Interior lever in black
- Oval rose escutcheons for profile cylinder, black
- Black cover caps
- Glazing frame in black

Per door **220**



THP 700

- Lever handle set lever handle/lever handle D-110, black
- Round rose escutcheons for profile cylinders, black
- Black cover caps
- Glazing frame in black

Per door **165**

# Thermo65 entrance doors

## Entrance door programme

### Accessories



#### Multiple-point locking £

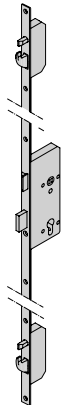

##### Automatic lock

- Multiple-point locking with main lock and 2 bolts, swing / hook bolt combination
- Mechanical self-locking mechanism
- For Thermo65 with handle HB 14-2, HB 38-2 and HB 38-3
- For Thermo65 with lever / knob handle set ES 0 / ES 1
- For Thermo65 with rose escutcheon knob / lever handle

Per door **70**

##### Note:

- Not possible in combination with electric strike.

#### Entrance door automation with BiSecur £

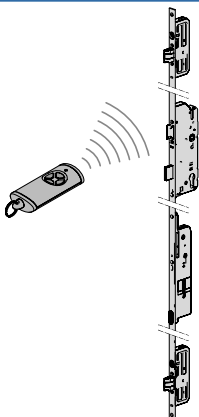

##### BiSecur

##### Multiple-point locking with opening via a hand transmitter

- Automatic lock with electric motor
- Including 1 hand transmitter HSE 4 BS
- For Thermo65 with handle HB 14-2 / HB 38-2 / HB 38-3
- For Thermo65 with lever / knob handle set ES 0 / ES 1

Per door **1014**

##### Note:

- Not possible in combination with electric strike.

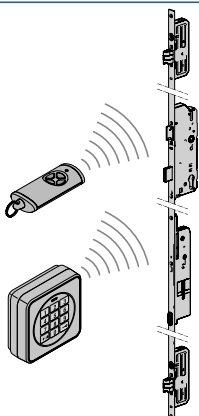

##### BiSecur

##### Multiple-point locking with opening via a radio code switch and hand transmitter

- Automatic lock with electric motor
- Including 1 hand transmitter HSE 4 BS and 1 radio code switch FCT3-1 BS
- For Thermo65 with handle HB 14-2 / HB 38-2 / HB 38-3
- For Thermo65 with lever / knob handle set ES 0 / ES 1

Per door **1107**

##### Note:

- Not possible in combination with electric strike.

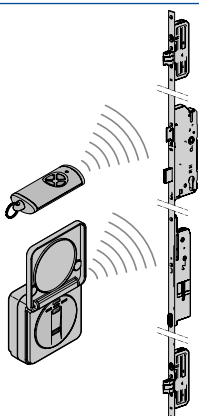

##### BiSecur

##### Multiple-point locking with opening via a radio finger-scan and hand transmitter

- Automatic lock with electric motor
- Including 1 hand transmitter HSE 4 BS and 1 finger-scan FFL 25 BS (up to 25 fingerprints can be taught in, cannot be individually deleted)
- For Thermo65 with handle HB 14-2 / HB 38-2 / HB 38-3
- For Thermo65 with lever / knob handle set ES 0 / ES 1

Per door **1269**

##### Note:

- Not possible in combination with electric strike.

# Thermo65 entrance doors

## Entrance door programme

### Accessories



#### Entrance door automation with BiSecur

£

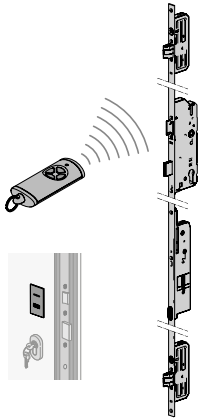

#### BiSecur

##### Multiple-point locking with opening via an integrated finger-scan and hand transmitter

- Automatic lock with electric motor
- Including 1 hand transmitter HSE 4 BS and 1 finger-scan integrated into the door leaf (up to 150 fingerprints can be taught in)
- For Thermo65 with handle HB 14-2 / HB 38-2 / HB 38-3
- For Thermo65 with lever / knob handle set ES 0 / ES 1

Per door **1580**

#### Note:

- Not possible in combination with electric strike.
- From RAM height 2005 mm

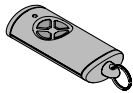

#### Additional 4-button hand transmitter HSE 4 BS

- In black
- Textured plastic surface with plastic caps

Each **59**

#### Entrance door automation with Bluetooth®

£

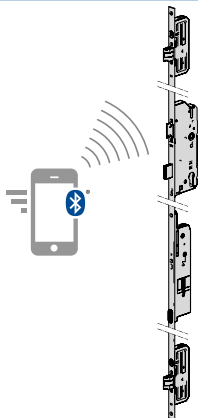

#### Bluetooth®

##### Multiple-point locking with opening via Bluetooth®

- Automatic lock with electric motor
- including Bluetooth® receiver
- For Thermo65 with handle HB 14-2 / HB 38-2 / HB 38-3
- For Thermo65 with lever / knob handle set ES 0 / ES 1

Per door **995**

The use requires a Smartphone or Tablet with Bluetooth® function and access to the App Store<sup>SM</sup> or Google Play<sup>TM</sup> (Hörmann BlueSecur App).  
A Smartphone or Tablet is not included in the scope of delivery!

#### Note:

- Not possible in combination with electric strike.
- Bluetooth® is not compatible with the BiSecur radio technology!

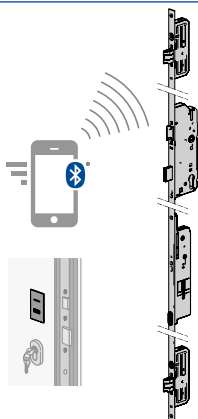

#### Bluetooth®

##### Multiple-point locking with opening via Bluetooth® and integrated finger-scan

- Automatic lock with electric motor
- Including Bluetooth® receiver and 1 finger-scan integrated into the door leaf (up to 150 fingerprints can be taught in)
- For Thermo65 with handle HB 14-2 / HB 38-2 / HB 38-3
- For Thermo65 with lever / knob handle set ES 0 / ES 1

Per door **1561**

The use requires a Smartphone or Tablet with Bluetooth® function and access to the App Store<sup>SM</sup> or Google Play<sup>TM</sup> (Hörmann BlueSecur App).  
A Smartphone or Tablet is not included in the scope of delivery!

#### Note:

- Not possible in combination with electric strike.
- Bluetooth® is not compatible with the BiSecur radio technology!
- From RAM height 2005 mm

# Thermo65 entrance doors

## Entrance door programme

### Accessories



<b>Emergency exit lock acc. to EN 179</b>	<b>Surcharges</b>	<b>£</b>
---	-------------------	----------

**Note:**

The rose escutcheons are only possible from a RAM width of 900 mm for styles THP 410 and THP 430.

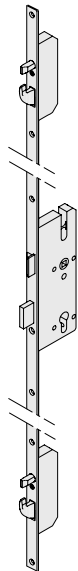

**Multiple-point locking with anti-panic function E**

- Anti-panic lock with stainless steel lock cover, distance 92 mm
- for the size range 1990 – 2250 mm

Each **174**

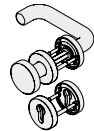

**Lever / knob handle set, rose escutcheon prepared for profile cylinder**

Black plastic Each **142**

Anodised aluminium (F1) Each **221**

**Knob K-130 / lever handle, type D-110**

Brushed stainless steel Each **286**

**Multiple-point locking with passage function D**

- Anti-panic lock with stainless steel lock cover, distance 92 mm
- for the size range 1990 – 2250 mm

Each **239**

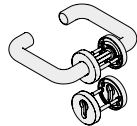

**Anti-panic lever handle set with split spindle, rose escutcheon prepared for profile cylinder**

Black plastic Each **142**

Anodised aluminium (F1) Each **221**

Brushed stainless steel Each **286**

**Lever handle / lever handle, type D-110**

**Multiple-point locking with change-over function B**

- Anti-panic lock with stainless steel lock cover, distance 92 mm
- for the size range 1990 – 2250 mm

Each **239**

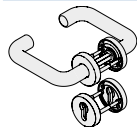

**Anti-panic lever handle set with split spindle, rose escutcheon prepared for profile cylinder**

Black plastic Each **142**

Anodised aluminium (F1) Each **221**

Brushed stainless steel Each **286**

**Lever handle / lever handle, type D-110**

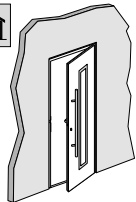

**Door set opening outwards**

Per door **81**

**Escape door function acc. to DIN EN 179**

Emergency exit lock acc. to DIN EN 179

**Surcharge see above**

Optional escape door function (capacity for release) must be stated with the order

**No surcharge**

# Thermo65 entrance doors

## Entrance door programme

### Accessories

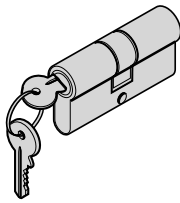

Profile cylinder			£
	Profile cylinder (40.5 + 40.5 mm) For HB 14-2, HB 38-2 and HB 38-3 push bars	With 8 keys	Each <b>74</b>
		With 10 keys	Each <b>92</b>
	Profile cylinder (45.5 + 45.5 mm) For ES 0 fittings	With 5 keys	Each <b>48</b>
		With 8 keys	Each <b>74</b>
		With 10 keys	Each <b>92</b>
	Profile cylinder (45.5 + 45.5 mm) with drilling and pull-off protection and security card for HB 14-2, HB 38-2 and HB 38-3 push bars with security rose escutcheon ES 1	With 5 keys	Each <b>83</b>
		With 8 keys	Each <b>109</b>
		With 10 keys	Each <b>127</b>
	Profile cylinder (45.5 + 45.5 mm) with drilling and pull-off protection and security card For ES 1 fittings:	With 5 keys	Each <b>83</b>
		With 8 keys	Each <b>109</b>
With 10 keys		Each <b>127</b>	
Profile cylinder (40.5 + 40.5 mm) For rose escutcheons	With 5 keys	Each <b>48</b>	
	With 8 keys	Each <b>74</b>	
	With 10 keys	Each <b>92</b>	
Profile cylinder, keys to pass, for push bar or ES 0 fittings	With 5 keys	Each <b>48</b>	
	With 8 keys	Each <b>74</b>	
	With 10 keys	Each <b>92</b>	
<b>Note:</b> No keys to pass for the profile cylinder from the fitting pack!			
Profile cylinder, keys to pass, with drilling and pull-off protection and security card for ES 1 fittings	With 5 keys	Each <b>83</b>	
	With 8 keys	Each <b>109</b>	
	With 10 keys	Each <b>127</b>	
<b>Note:</b> No keys to pass for the profile cylinder from the fitting pack!			

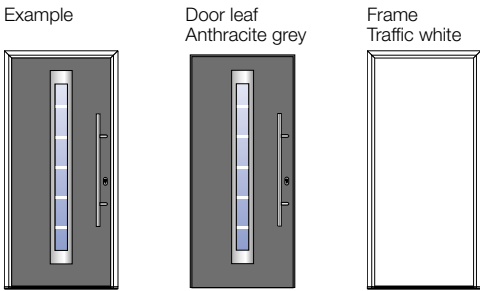
Door leaf and frame in different colours / surface finishes				
Colours of door leaf and frame do not match		Door leaf	Frame	Price for entrance door with surface
		RAL 9016	Preferred colour	<b>Preferred colour</b>
		RAL 9016	Matt deluxe	<b>Matt deluxe</b>
		RAL 9016	Decor	<b>Decor</b>
		Preferred colour	RAL 9016	<b>Preferred colour</b>
		Preferred colour	Preferred colour	<b>Preferred colour</b>
		Preferred colour	Matt deluxe	<b>Matt deluxe</b>
		Preferred colour	Decor	<b>Decor</b>
		Matt deluxe	RAL 9016	<b>Matt deluxe</b>
		Matt deluxe	Matt deluxe	<b>Matt deluxe</b>
		Matt deluxe	Preferred colour	<b>Matt deluxe</b>
		Matt deluxe	Decor	<b>Decor</b>
		Decor	RAL 9016	<b>Decor</b>
		Decor	Matt deluxe	<b>Decor</b>
		Decor	Preferred colour	<b>Decor</b>
		Decor	Decor	<b>Decor</b>

# Thermo65 entrance doors

## Entrance door programme

### Accessories



Two-colour entrance doors, side elements or transom light		Surcharge	£
<ul style="list-style-type: none"> <li>Door leaf and frame / side element / transom light                             <ul style="list-style-type: none"> <li>– Exterior <b>RAL 7016 Anthracite grey</b> or <b>CH 907 Grey aluminium</b></li> <li>– Interior in Traffic white RAL 9016</li> </ul> </li> <li><b>for frame profile A4</b></li> <li>Opening inwards</li> <li>Not possible for styles THP 100, THP 410, THP 430 and THP 610!</li> </ul>	Surcharge on version in preferred colour	Per door	<b>128</b>
		Per side element	<b>60</b>
		Per transom light	<b>60</b>

Entrance door / side element Thermo65

Exterior preferred colour  
RAL 7016 or CH907

Interior Traffic white  
RAL 9016

**A4 profile**

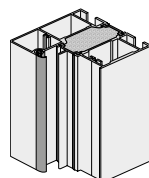
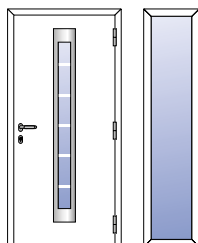
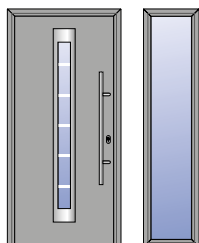

Example THP 750

<ul style="list-style-type: none"> <li>Door leaf and frame / side element / transom light                             <ul style="list-style-type: none"> <li>– Exterior in <b>decors Golden Oak, Dark Oak or Titan Metallic CH 703</b></li> <li>– Interior in Traffic white RAL 9016</li> </ul> </li> <li><b>for frame profile A3</b></li> <li>Opening inwards</li> <li>Not possible for styles THP 100, THP 410, THP 430 and THP 610!</li> </ul>	Surcharge for version with decor surface	Per door	<b>128</b>
		Per side element	<b>60</b>
		Per transom light	<b>60</b>

Entrance door / side element Thermo65, exterior decor

Golden Oak

Dark Oak

Titan Metallic CH 703

Interior RAL 9016  
Traffic white

**Profile A3**

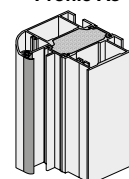
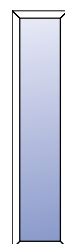
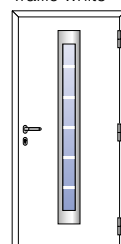
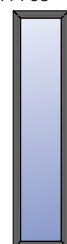
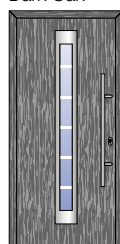
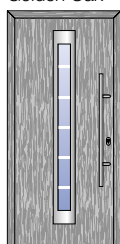

Example THP 750

### Threshold / bottom door edge

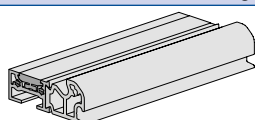

**Threshold S11**  
(Standard)

**No surcharge**

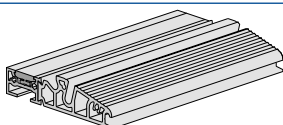

**Threshold S12**  
(Optional)

Each **37**

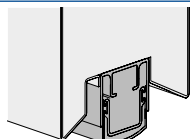

**Retractable bottom seal**  
(Frame without threshold)

Each **305**

**Notes:**

- Not for styles 100, 410 and 430!
- The performance characteristics thermal insulation ( $U_b$ ) and water-tightness under heavy rain are limited!



# Thermo65 entrance doors

## Entrance door programme

### Accessories





Profiles						£
	<b>Bottom edge profile 50 mm</b> <ul style="list-style-type: none"> <li>• Dimensions (B x H) 80 x 50 mm</li> <li>• Fitting under the threshold S12</li> <li>• With double-sided adhesive tape for sealing</li> </ul>	RAL 9016	Per m			<b>69</b>
		Preferred colour	Per m			<b>80</b>
		Matt deluxe	Per m			<b>91</b>
	<b>Bottom spacer profile</b>	Length up to 1250 mm	Height	30 mm	Each	<b>28</b>
			Height	60 mm	Each	<b>55</b>
			Height	90 mm	Each	<b>83</b>
			Height	120 mm	Each	<b>110</b>
			Height	150 mm	Each	<b>138</b>
		Length up to 2250 mm	Height	30 mm	Each	<b>46</b>
			Height	60 mm	Each	<b>91</b>
			Height	90 mm	Each	<b>136</b>
			Height	120 mm	Each	<b>181</b>
			Height	150 mm	Each	<b>226</b>
		Length up to 3250 mm	Height	30 mm	Each	<b>65</b>
			Height	60 mm	Each	<b>130</b>
			Height	90 mm	Each	<b>195</b>
			Height	120 mm	Each	<b>260</b>
			Height	150 mm	Each	<b>325</b>
	<b>Base profile</b> (black)	Length up to 1250 mm	Height	15 mm	Each	<b>28</b>
		Length up to 2250 mm	Height	15 mm	Each	<b>46</b>
		Length up to 3250 mm	Height	15 mm	Each	<b>65</b>
	<b>Extension profile 25 mm</b> Dimensions (W x D): 25 x 80 mm	RAL 9016	Per m			<b>63</b>
		Preferred colour	Per m			<b>74</b>
		Matt deluxe	Per m			<b>85</b>
		Golden Oak, Dark Oak, Night Oak, Winchester Oak, Titan Metallic CH 703	Per m			<b>85</b>
	<b>Extension profile 50 mm</b> Dimensions (W x D): 50 x 80 mm	RAL 9016	Per m			<b>69</b>
		Preferred colour	Per m			<b>80</b>
		Matt deluxe	Per m			<b>91</b>
	<b>Cover profile</b> Per package 2 x 2300 mm and 1 x 1300 mm Dimensions (W x D): 50 x 5 mm Profiles sufficient for a door without side elements.	RAL 9016	Per box			<b>129</b>
		Golden Oak, Dark Oak, Night Oak, Winchester Oak, Titan Metallic CH 703	Per box			<b>173</b>
	<b>Supplementary profile (on 3 sides)</b> Width 20 mm, mitred, incl. corner bracket and fitting screws	RAL 9016	Per door			<b>265</b>
		Preferred colour	Per door			<b>333</b>
		Matt deluxe	Per door			<b>345</b>
		Golden Oak, Dark Oak, Titan Metallic CH 703	Per door			<b>345</b>

# Thermo65 entrance doors

Entrance door programme

## Accessories

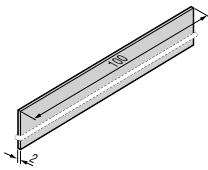
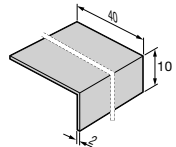
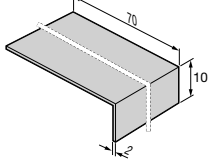
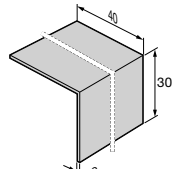
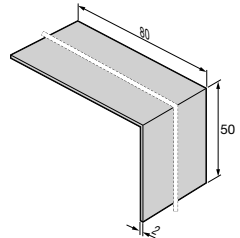
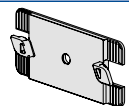

Additional profiles – flat aluminium				£
	<b>Flat aluminium 20 x 2 mm</b>	RAL 9016	Length 2900 mm	Per lath <b>40</b>
		Preferred colour	Length 2900 mm	Per lath <b>50</b>
		Matt deluxe	Length 2300 mm	Per lath <b>62</b>
	<b>Flat aluminium 30 x 2 mm</b>	RAL 9016	Length 2900 mm	Per lath <b>48</b>
		Preferred colour	Length 2900 mm	Per lath <b>58</b>
		Matt deluxe	Length 2300 mm	Per lath <b>70</b>
	<b>Flat aluminium 50 x 2 mm</b>	RAL 9016	Length 2900 mm	Per lath <b>88</b>
		Preferred colour	Length 2900 mm	Per lath <b>98</b>
		Matt deluxe	Length 2300 mm	Per lath <b>110</b>
	<b>Flat aluminium 100 x 2 mm</b>	RAL 9016	Length 2900 mm	Per lath <b>106</b>
		Preferred colour	Length 2900 mm	Per lath <b>116</b>
		Matt deluxe	Length 2300 mm	Per lath <b>127</b>
Additional profiles – aluminium bracket				£
	<b>Aluminium bracket 40 x 10 x 2 mm</b>	RAL 9016	Length 2900 mm	Per lath <b>79</b>
		Preferred colour	Length 2900 mm	Per lath <b>88</b>
		Matt deluxe	Length 2300 mm	Per lath <b>99</b>
	<b>Aluminium bracket 70 x 10 x 2 mm</b>	RAL 9016	Length 2900 mm	Per lath <b>88</b>
		Preferred colour	Length 2900 mm	Per lath <b>98</b>
		Matt deluxe	Length 2300 mm	Per lath <b>110</b>
	<b>Aluminium bracket 40 x 30 x 2 mm</b>	RAL 9016	Length 2900 mm	Per lath <b>88</b>
		Preferred colour	Length 2900 mm	Per lath <b>98</b>
		Matt deluxe	Length 2300 mm	Per lath <b>110</b>
	<b>Aluminium bracket 80 x 50 x 2 mm</b>	RAL 9016	Length 2900 mm	Per lath <b>106</b>
		Preferred colour	Length 2900 mm	Per lath <b>116</b>
		Matt deluxe	Length 2300 mm	Per lath <b>127</b>
Screw-in latch				£
	<b>Screw-in bracket for flat aluminium and aluminium bracket</b> Content: 11 units			Per set <b>42</b>

# Thermo65 entrance doors

## Entrance door programme

### Accessories





Door closers		£
	<b>Door leaf preparation for door closer</b> (reinforcement in door leaf)	Each <b>32</b>
	<b>Door closer HDC 35 for fitting on opening side (hinge side)</b> For aluminium frame profile A3 or A4	Each <b>188</b>
	<b>Door closer HDC 35 for fitting on closing side (opposite hinge side)</b> For aluminium frame profile A4	Each <b>188</b>
	<b>Mechanical hold-open device</b>	Each <b>74</b>
<b>Accessories</b>		<b>£</b>
	<b>Electric strike with day catch</b> (separate)  <b>Function:</b> For opening, the circuit is closed by operating an electrical switch and the latch is released (operating current electric strike).  <b>Note:</b> Not possible in conjunction with an automatic lock.	Each <b>115</b>
	<b>Electric strike with day catch and stop</b> (separate)  <b>Function:</b> When actuated, the mechanism in the electric strike is released and remains unlocked until the door is opened. One-time entry is possible.  <b>Note:</b> Not possible in conjunction with an automatic lock.	Each <b>148</b>
	<b>Latch switching contact</b> For main latch, main lock  <b>Note:</b> Not possible in conjunction with entrance door automation.	Each <b>109</b>
	<b>Reed contact</b> (separate), door leaf and frame prepared	Each <b>109</b>
	<b>Door set opening outwards</b>	Per door <b>81</b>
	<b>Spyhole (fitted)</b> (only for THP 010, THP 015, THP 100, THP 410 and THP 515)	Each <b>54</b>
	<b>Spyhole, with thermal break (fitted)</b> (only for THP 010, THP 015, THP 100, THP 410 and THP 515)	Each <b>109</b>
	<b>Rain canopy</b> Anodised aluminium	Each <b>26</b>

# Thermo65 entrance doors

## Entrance door programme

### Accessories

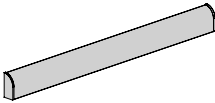
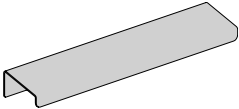

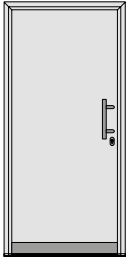
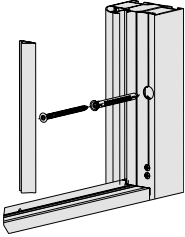
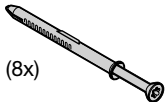
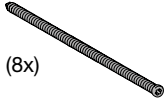
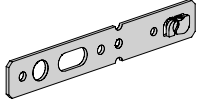
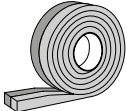
Accessories		£						
	<b>Door drip</b> (aluminium painted)	RAL 9016 Traffic white Each <b>37</b>						
		Stainless steel look Each <b>55</b>						
	<b>Door drip</b>	Stainless steel Each <b>227</b>						
	<b>Stainless steel cleaner and care product</b> (150 ml)	Each <b>35</b>						
	<b>Stainless steel bottom sheet on the exterior (separate)</b> <ul style="list-style-type: none"> <li>• Bottom sheet height 110 mm</li> <li>• Size range of heights for style</li> </ul> <table border="1"> <thead> <tr> <th>Style</th> <th>Height (RAM)</th> </tr> </thead> <tbody> <tr> <td>010</td> <td>1875 – 2250 mm</td> </tr> <tr> <td>100/410/430/015/515/600/700/750/800/810/850/900</td> <td>2050 – 2250 mm</td> </tr> </tbody> </table>	Style	Height (RAM)	010	1875 – 2250 mm	100/410/430/015/515/600/700/750/800/810/850/900	2050 – 2250 mm	Per door <b>193</b>
		Style	Height (RAM)					
010	1875 – 2250 mm							
100/410/430/015/515/600/700/750/800/810/850/900	2050 – 2250 mm							
<b>Notes:</b> <ul style="list-style-type: none"> <li>• Not in combination with embellishments in stainless steel look, view 451, 454, 457, 459, 750 and 751.</li> <li>• Not in conjunction with the door drip.</li> </ul>								
	<b>Through-bolt fixing (4 fitting holes for each side bar)</b> For aluminium frame profile A3 and A4	Per door <b>81</b>						
Fixing material		£						
 (8x)	<b>Plug-and-screw set</b> 8 x screws and 8 x plugs, 8 x 120 mm	Per set <b>26</b>						
 (8x)	<b>Frame screws</b> 8 x frame screws 7.5 x 182 mm	Per set <b>26</b>						
	<b>Screw-in anchor set</b> Length 280 mm (8 x anchors)	Per set <b>31</b>						
	<b>Pre-compressed sealing strip (74 mm wide)</b> <b>for groove widths from 6 – 15 mm</b> (approved for RAL fitting)	Per roll <b>124</b>						

# Thermo65 entrance doors

## Entrance door programme

### Accessories













#### Entrance door in RC 2 version (for a product description, see page 25) £

- ▶ Hook bolt lock: attack side = opening or closing side (hinge side or opposite hinge side)
- ▶ Multiple-point locking (automatic lock): attack side = opening or closing side (hinge side or opposite hinge side)
- ▶ Multiple-point locking (automatic lock with electric motor): attack side = opening or closing side (hinge side or opposite hinge side)

RC 2		Package HB 14-2 with security rose escutcheon	Stainless steel	Per door	142	
		Package HB 38-2 with security rose escutcheon	Stainless steel	Per door	142	
		Package HB 38-3 with security rose escutcheon	Stainless steel	Per door	142	
		ES 1 fittings	Knob / lever handle	Stainless steel	Per door	220
			Lever handle / lever handle	Stainless steel	Per door	220

RC 2		Package HB 14-2 with security rose escutcheon and safety glass (P4A)	Stainless steel	Per door	261	
		Package HB 38-2 with security rose escutcheon and safety glass (P4A)	Stainless steel	Per door	261	
		Package HB 38-3 with security rose escutcheon and safety glass (P4A)	Stainless steel	Per door	261	
		ES 1 fittings and safety glass (P4A)	Knob / lever handle	Stainless steel	Per door	339
			Lever handle / lever handle	Stainless steel	Per door	339

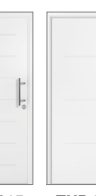
#### Approved size range for RC 2 version for each style

											
Width	875 – 1100	700 – 1250				800 – 1250			875 – 1250		
Height	1875 – 2186	1875 – 2250				1875 – 2250			1875 – 2250		

#### Side elements and transom lights in RC 2 £

RC 2		Clear glass and safety glass (P4A)	Per side element	184
	<b>Side elements</b> Only possible in the size range with a width of 300 – 550 mm (overall frame dimension).	Satinato and safety glass (P4A)	Per side element	184
		Sand-blasted and safety glass (P4A)	Per side element	184
		Sand-blasted with clear stripes and safety glass (P4A)	Per side element	184
		RC 2		Clear glass and safety glass (P4A)
	<b>Transom lights</b> Only possible in the size range with a height of 300 – 500 mm (overall frame dimension).	Satinato and safety glass (P4A)	Per transom light	184
		Sand-blasted and safety glass (P4A)	Per transom light	184

#### Example for calculating an entrance door as an RC 2 version £

Conversion  
THP 700 with HB 38-2  
to  
Package HB 38-2 with security  
rose escutcheon

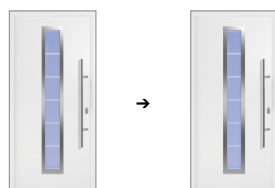

Style THP 700 in RAL 9016, profile A3 (standard size)	2572
+ Conversion for package HB 38-2 with security rose escutcheon	261
= Total	2833

#### Accessory package "black.edition" for RC 2





See page 54

# Thermo65 entrance doors

## Entrance door programme

### Accessories



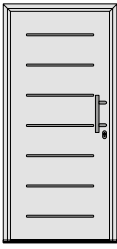
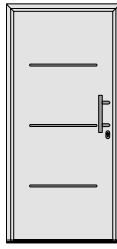
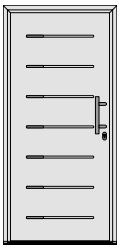
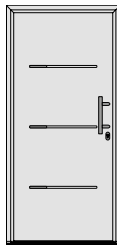
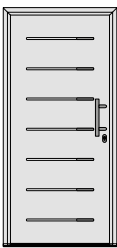
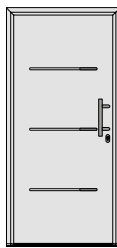
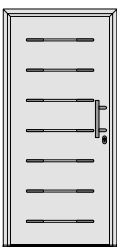
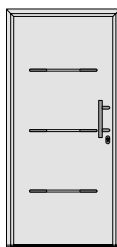

Accessory package "black.edition" for RC 2		Surcharge	£
  	<ul style="list-style-type: none"> <li>Exterior push bar HN 38-2 in black</li> <li>Interior lever in black</li> <li>ES 1 round rose escutcheons for profile cylinders, black</li> <li>Black cover caps</li> </ul>	Surcharge on RC 2 version per door	<b>110</b>
	<ul style="list-style-type: none"> <li>Exterior push bar HN 38-2 in black</li> <li>Interior lever in black</li> <li>ES 1 round rose escutcheons for profile cylinders, black</li> <li>Black cover caps</li> <li>Glazing frame in black</li> </ul>	Surcharge on RC 2 version per door	<b>220</b>
Embellishments (on the exterior)			£
 	<p><b>Embellishment in stainless steel look, view 400</b> Inlay length 577 mm per rib</p>	<p><b>Style THP 015</b> Per door</p>	<b>204</b>
		<p><b>Style THP 515</b> Per door</p>	<b>135</b>
 	<p><b>Embellishment in stainless steel look, view 401</b> Inlay length 118 mm per rib</p>	<p><b>Style THP 015</b> Per door</p>	<b>204</b>
		<p><b>Style THP 515</b> Per door</p>	<b>135</b>
 	<p><b>Embellishment in stainless steel look, view 402</b> Inlay length 118 mm per rib</p>	<p><b>Style THP 015</b> Per door</p>	<b>204</b>
		<p><b>Style THP 515</b> Per door</p>	<b>135</b>
 	<p><b>Embellishment in stainless steel look, view 403</b> Inlay length 2 x 118 mm per rib</p>	<p><b>Style THP 015</b> Per door</p>	<b>204</b>
		<p><b>Style THP 515</b> Per door</p>	<b>135</b>

# Thermo65 entrance doors

## Entrance door programme

### Accessories

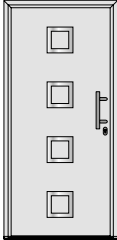
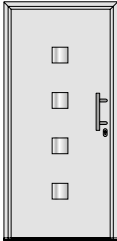
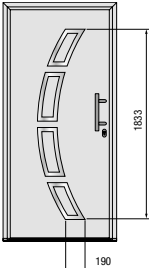
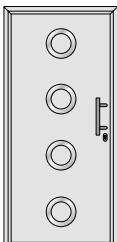
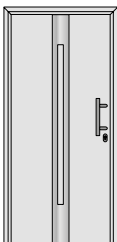

Embellishments for style THP 010 (on the exterior)			Surcharge	£	
	<b>View 451</b>	<b>Stainless steel frames</b> Overall dimension 240 x 240 mm Inside dimension 160 x 160 mm ▷ From RAM height 2000 mm	Style THP 010	Per door	<b>261</b>
	<b>View 454</b>	<b>Stainless steel frames</b> Overall dimension 145 x 145 mm ▷ From RAM height 2000 mm	Style THP 010	Per door	<b>261</b>
	<b>View 457</b>	<b>Curved stainless steel frames</b> ▷ From RAM height 2000 mm	Style THP 010	Per door	<b>261</b>
	<b>View 459</b>	<b>Stainless steel rings</b> Overall dimension Ø 240 mm Inside dimension Ø 160 mm ▷ From RAM height 2000 mm	Style THP 010	Per door	<b>261</b>
	<b>View 750</b>	<b>Stainless steel frame over entire leaf height</b> ▷ From RAM height 2000 mm	Style THP 010	Per door	<b>261</b>
	<b>View 751</b>	<b>3 parallel stainless steel strips over the entire leaf height</b> ▷ From RAM height 2000 mm	Style THP 010	Per door	<b>261</b>

# Thermo65 entrance doors

## Entrance door programme

### Side elements and transom lights



#### Side element

##### Fixed side element assembly

###### Standard size

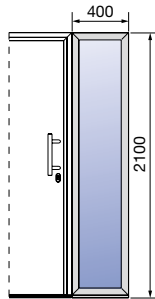

Ordering sizes RAM (mm) Width x height	Glass	RAL 9016	Preferred colour	Matt deluxe	Decor
400 x 2100 400 x 2200	Clear	1035	1167	1255	1210
	Satinato	1035	1167	1255	1210
	Sand-blasted	1035	1167	1255	1210
	Sand-blasted with clear stripes	1596	1728	1816	1771
	One-way plate glass	1200	1332	1420	1375

#### Side element

##### Fixed side element assembly

###### Special sizes

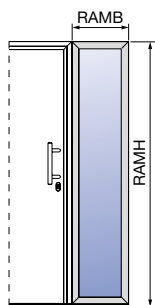

Ordering sizes RAM up to (mm) Width x height	Glass In accordance with the overview on page 57	RAL 9016	Preferred colour	Matt deluxe	Decor
From 300 x 700 Up to 500 x 2250	Clear, Satinato or sand-blasted	1235	1367	1455	1410
Up to 1000 x 2250 *		1432	1564	1652	1607
From 300 x 700 Up to 500 x 2250	One-way plate glass	1400	1532	1620	1575
Up to 1000 x 2250 *		1597	1729	1817	1772
From 300 x 1875 Up to 500 x 2250	Sand-blasted with clear stripes	1943	2075	2163	2118
Up to 1000 x 2250 *		2138	2270	2358	2313

\* Only possible without transom light  
Door set with side element does not contribute to the static equilibrium. Statics must be ensured by the building structure.

#### Transom light

##### Fixed transom light assembly

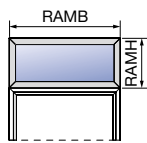

Ordering sizes RAM (mm) Width x height	Glass In accordance with the overview on page 57	RAL 9016	Preferred colour	Matt deluxe	Decor
From 700 x 300 Up to 1250 x 500	Clear, Satinato or sand-blasted	832	964	1052	1007
Up to 1750 x 500		1003	1135	1223	1178
Up to 2250 x 500		1234	1366	1454	1409
From 700 x 300 Up to 1250 x 500	One-way plate glass	997	1129	1217	1172
Up to 1750 x 500		1167	1299	1387	1342
Up to 2250 x 500		1399	1531	1619	1574

**RAMB** = Overall frame width  
**RAMH** = Overall frame height





# Thermo65 entrance doors

## Entrance door programme

### Overview of glass for side elements

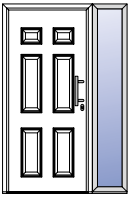
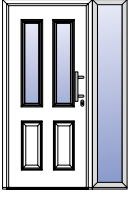

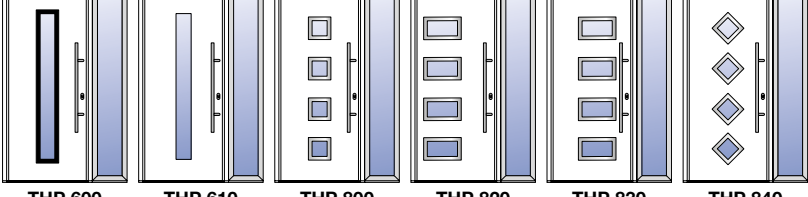
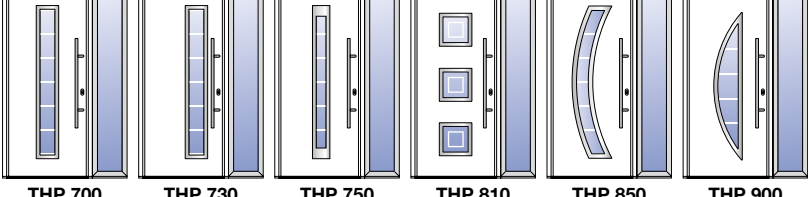
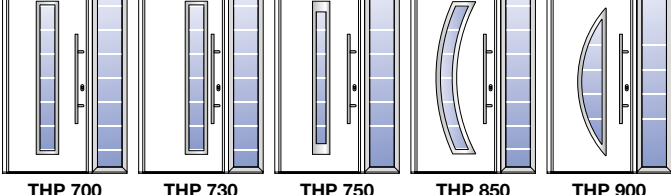
Infill / size range			
Glass design: exterior pane clear laminated safety glass – intermediate pane – interior pane clear laminated safety glass			
Style	Glass (Intermediate pane)	Size range	
		Side element (mm)	Transom light (mm)
 <p>THP 010    THP 015    THP 515</p>	<ol style="list-style-type: none"> <li>Sand-blasted without clear stripes</li> <li>Satinato</li> <li>Clear</li> <li>One-way plate glass</li> </ol>	<p><b>Width</b> 300–1000</p> <p><b>Height</b> 700–2250</p>	<p><b>Width</b> 700–2250</p> <p><b>Height</b> 300–500</p>
 <p>THP 100</p>	<ol style="list-style-type: none"> <li>Sand-blasted without clear stripes</li> <li>Satinato</li> <li>Clear</li> <li>One-way plate glass</li> </ol>	<p><b>Width</b> 300–1000</p> <p><b>Height</b> 700–2186</p>	<p><b>Width</b> 875–2000</p> <p><b>Height</b> 300–500</p>
 <p>THP 410</p>	<ol style="list-style-type: none"> <li>Satinato</li> <li>Clear</li> </ol>	<p><b>Width</b> 300–1000</p> <p><b>Height</b> 700–2186</p>	<p><b>Width</b> 875–2250</p> <p><b>Height</b> 300–500</p>
 <p>THP 430</p>	<ol style="list-style-type: none"> <li>Sand-blasted without clear stripes</li> <li>Clear</li> </ol>	<p><b>Width</b> 300–1000</p> <p><b>Height</b> 700–2186</p>	<p><b>Width</b> 875–2000</p> <p><b>Height</b> 300–500</p>
 <p>THP 600    THP 610    THP 800    THP 820    THP 830    THP 840</p>	<ol style="list-style-type: none"> <li>Satinato</li> <li>Clear</li> </ol>	<p><b>Width</b> 300–1000</p> <p><b>Height</b> 700–2250</p>	<p><b>Width</b> 700–2250</p> <p><b>Height</b> 300–500</p>
 <p>THP 700    THP 730    THP 750    THP 810    THP 850    THP 900</p>	<ol style="list-style-type: none"> <li>Sand-blasted without clear stripes</li> <li>Clear</li> <li>One-way plate glass*</li> </ol> <p>* Only for styles THP 700N and 810N</p>	<p><b>Width</b> 300–1000</p> <p><b>Height</b> 700–2250</p>	<p><b>Width</b> 700–2250</p> <p><b>Height</b> 300–500</p>
 <p>THP 700    THP 730    THP 750    THP 850    THP 900</p>	<ol style="list-style-type: none"> <li>Sand-blasted with clear stripes (only in side element)</li> </ol>	<p><b>Width</b> 300–1000</p> <p><b>Height</b> 1875–2250</p>	<p><b>Width</b> 700–2250</p> <p><b>Height</b> 300–500</p>



## Hörmann homee For a smart home

- Hörmann homee Brain basic cube with BiSecur radio system for operating Hörmann garage door operators, entrance gate operators, entrance door locks and electric devices with BiSecur receivers
- Extendable with further cubes for the ZigBee, EnOcean and Z-Wave radio technologies
- Control of individual devices, device groups or programmable scenarios “homeegramme” via the free smartphone app in the home network or worldwide via the Internet

**HÖRMANN**

# Notes and sketches

---

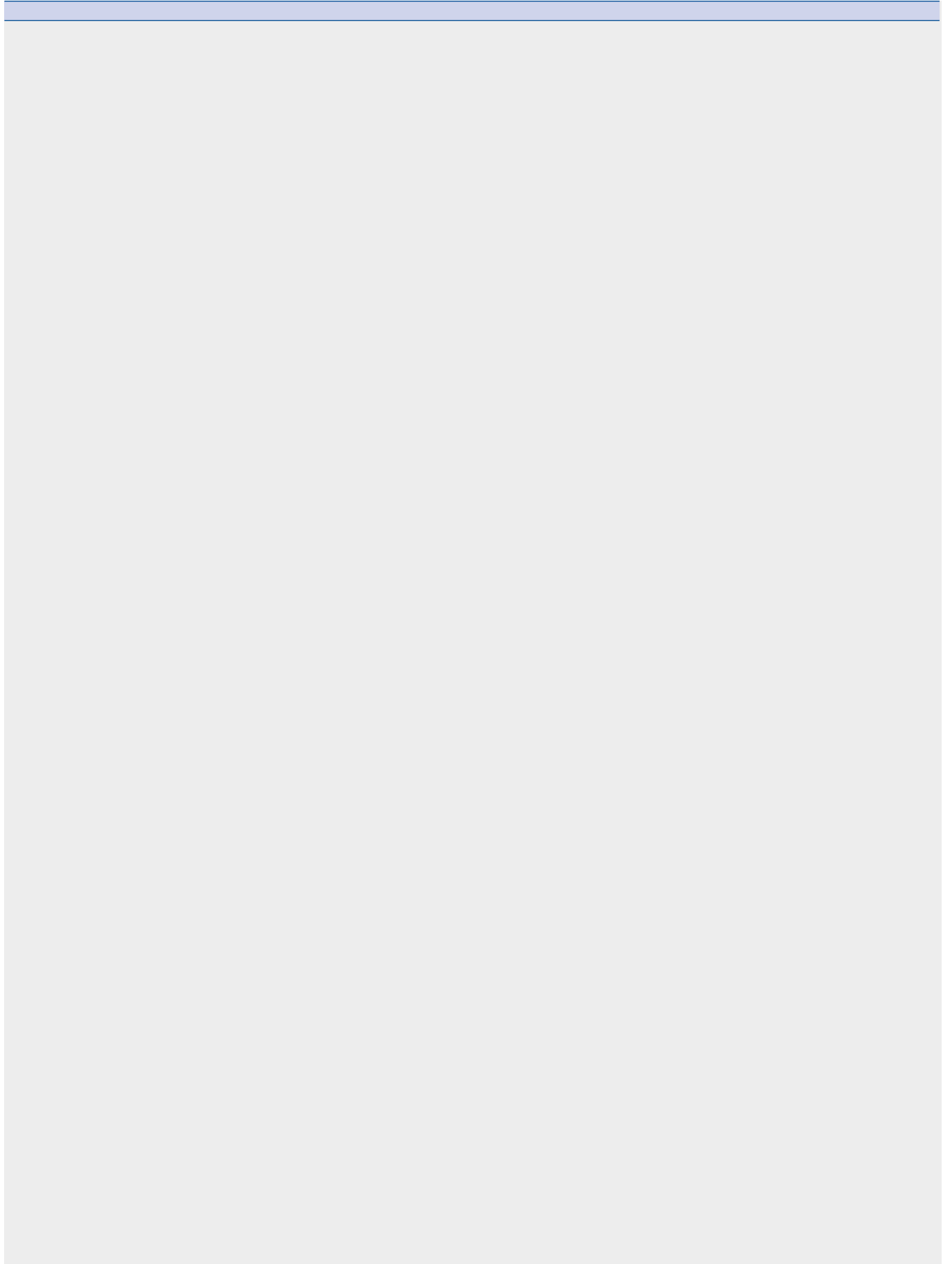

## Notes and sketches

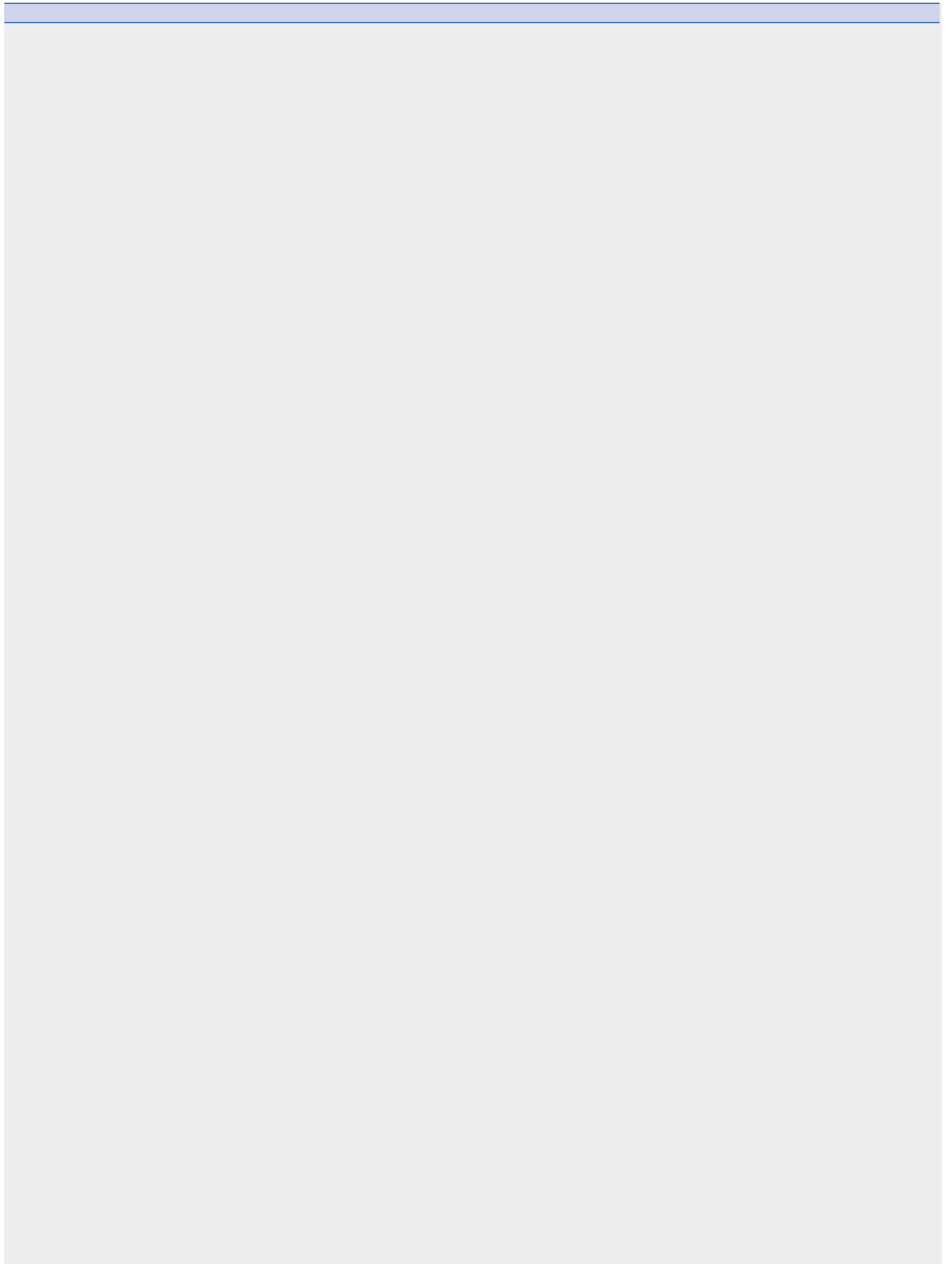

## Notes and sketches

---

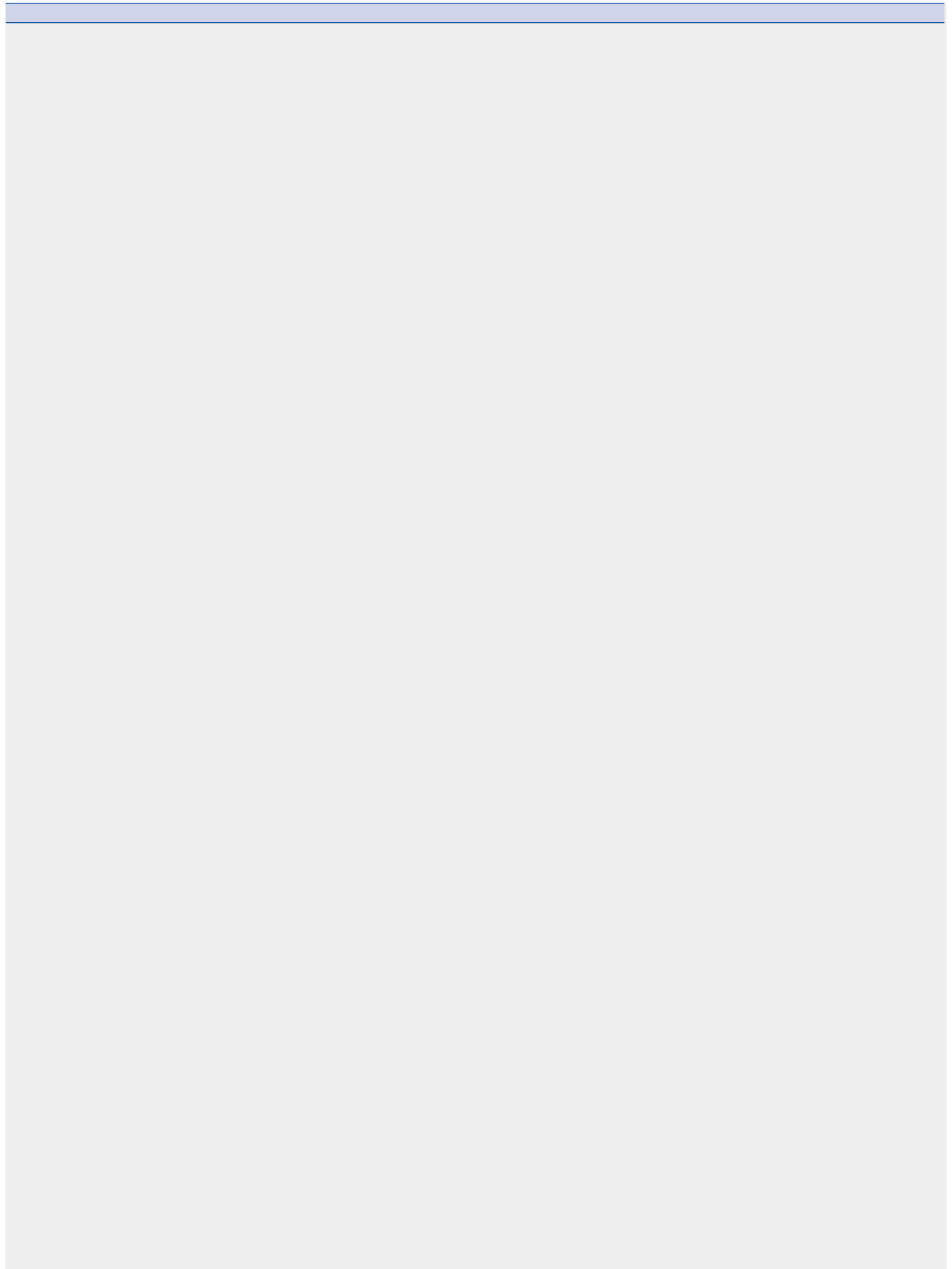



# Hörmann: Quality without Compromise



Hörmann KG Amshausen, Germany



Hörmann KG Antriebstechnik, Germany



Hörmann KG Brandis, Germany



Hörmann KG Brockhagen, Germany



Hörmann KG Dissen, Germany



Hörmann KG Eckelhausen, Germany



Hörmann KG Freisen, Germany



Hörmann KG Ichtershhausen, Germany



Hörmann KG Werne, Germany



Hörmann Alkmaar B.V., Netherlands



Hörmann Legnica Sp. z o.o., Poland



Hörmann Beijing, China



Hörmann Tianjin, China



Hörmann LLC, Montgomery IL, USA



Hörmann Flexon LLC, Burgettstown PA, USA



Shakti Hörmann Ltd., India

Hörmann is the only manufacturer worldwide that offers you a complete range of all major building products from one source. We manufacture in highly-specialised factories using the latest production technologies. The close-meshed network of sales and service companies throughout Europe, and activities in the USA and Asia, make Hörmann your strong partner for first-class building products, offering “Quality without Compromise”.

**GARAGE DOORS**  
**OPERATORS**  
**INDUSTRIAL DOORS**  
**LOADING EQUIPMENT**  
**HINGED DOORS**  
**DOOR FRAMES**

Hörmann (UK) Ltd  
Gee Road  
Coalville  
Leicestershire  
LE67 4JW

Tel: 01530 513000  
Fax: 01530 513001

[www.hormann.co.uk](http://www.hormann.co.uk)

**HÖRMANN**